

Serve

2026 COLLECTIONS UKI



steeliteutopia

THE ART OF PRESENTATION



steeliteutopia

THE ART OF PRESENTATION

You're not just setting a table. You're creating an experience, telling a story, sharing a culture - and food is at the heart of it. Food brings people together and connects them to tradition and inspiration.

At Steelite-Utopia, we believe that tableware should do more than serve your food - it should serve your vision. We design, craft and curate the very best in tableware for chefs and concepts across the globe.

Partnering to create an unmatched range of inspired tabletop experiences where shape, colour, texture, light and weight combine to feed the senses. Helping our customers set the stage for their menus and their brands. Elevating presentation to an art. Steelite-Utopia. The Art of Presentation.

United Through Innovation

Steelite-Utopia delivers a comprehensive and unmatched solution for the hospitality industry. Combining durable ceramic tableware with an extensive range of glassware, cutlery, buffet items, and lighting, we provide a cohesive product suite designed to meet every need of dining and hospitality presentation. Our products balance resilience with style, adhering to the highest quality standards while enhancing the dining experience through thoughtful design and expert craftsmanship.

Positioned to not only enhance its market presence but also to deliver unparalleled value to customers, offering a one-stop solution for all tableware needs with a focus on quality, innovation, and sustainability.



A truly global enterprise

With a wide range of products, Steelite-Utopia offers a unique solution for any venue. Dominating nearly every industry sector from commercial catering to leisure and hospitality markets, the opportunities are endless with our vast product portfolio. Our core dinnerware lines, Steelite Distinction and Steelite Performance, and proprietary brands, William Edwards, Utopia, Anton Black, Crown Glassware, Creations, Folio, Varick, Aspen, Strahl, D.W. Haber, Kenny Mack Designs, Hollowick and Illumina are complemented by collections from strategically chosen specialist partners.

Our Brands



Our Partners



Introduction	6	Platters, Bowls & Risers	118
Icon Guide.....	8	Ceramic.....	120
Axis Buffet System		Melamine.....	122
Creations.....	10	Resin.....	134
Fusion Buffet System		Stainless Steel Presentation.....	135
D.W. Haber.....	28	Risers & Stands.....	137
Visual Display	54	Seafood Stands.....	139
Wood Display.....	56	Plate Stands & Risers.....	142
Wood Presentation.....	57	Glass Domes & Risers.....	145
Slate Presentation.....	60	Hollowware & Accessories	148
Street Food Stands.....	61	Hollowware.....	150
Chafers & Cookware	62	Accessories & Trays.....	152
Hinged Chafers.....	66	Dash Bottles & Pourers.....	154
Homestyle Chafers.....	70	Holdings & Caddies.....	155
Hepp Chafers, Inserts & Accessories.....	76	Green Earth Cutlery & Skewers.....	158
Cast Iron & Boards.....	78	Carafes & Jugs.....	160
Eagle Enamel.....	80	Bottles.....	169
Ceramic Cookware.....	82	Condiments.....	173
Induction, Chafing Fuel & Burners	88	Storage Jars.....	174
Power Cell.....	90	Plastic Carafes, Pitchers & Jugs.....	176
Accessories.....	91	Placemats & Trivets.....	178
Chafing Fuel.....	92	Serving Utensils	180
Heat Lamps		Mogogo Buffet Solutions	186
Creations.....	94	Modular Collection.....	192
Beverage Service & Cereal Dispensers	98	Roll'n Service Carts.....	194
Juice Dispensers.....	100	Canvas Shelving System.....	196
Milk & Cereal Dispensers.....	104	Moby.....	200
Buffet Chillers.....	108	Oval Cart.....	202
Wine Coolers, Buckets & Stands.....	108	Cantine Display Cart.....	204
Custom Powder Coating	114	V-Shield Breath Guards.....	206
		Material Guide.....	208
		Quick Cover Guide.....	209
		Foodservice Equipment	210
		Care & Use	216
		Index	228

Scan the QR Codes below to see the full Steelite-Utopia offering



Eat

2026 Collections UKI



Drink

2026 Collections UKI



Visit Our Showrooms

Steelite Showrooms provide the perfect opportunity to explore our vast portfolio, and our knowledgeable sales team will offer a solution for any tabletop concept.

We are proud to have showrooms in these locations:



UK

- London
- Stoke-on-Trent
- Chesterfield



EU

- Bickenbach, Germany
- Madrid, Spain



ASIA

- Hong Kong

AUS

- Sydney, NSW



CA

- Toronto, Ontario

All Showrooms are available by appointment, please email to make a booking:
info@steelite-utopia.com







Icon Guide



Steelite International Made For Life

Each piece is inspected, examined and tested so you can be confident it will withstand the rigours of the modern commercial kitchen



Steelite International Lifetime Edge-Chip Warranty

Your assurance that all Performance and Distinction products manufactured in our UK factory are fit for purpose.



5 Year Edge Chip Warranty

Warrants a selection of products against edge chipping under normal usage conditions during the service life of the product.



Stacking

Items that are designed to stack when space is at a premium.



Crystal

A selection of glassware ranges that are made from fine crystal giving clarity and finer rims.



100% Recycled

Made from 100% recycled glass.



Starglass

The composition of selected raw materials gives this glass a high purity in the absence of heavy metals, to ensure 100% recyclable products. Exceptional brightness and clarity.



Lined & CE

Many of our glassware items can be government stamped and lined to satisfy all European legal hospitality requirements.



Polycarbonate

Polycarbonate is a very strong and virtually unbreakable plastic, the strongest plastic of all.



SAN

Styreneacrylonitrile is stronger than polystyrene and can take a high amount of usage but will break under heavy pressure.



Polystyrene

Not as strong as Polycarbonate, Polystyrene items are often used for shot glasses where strength is not as important.



Axis Buffet Collection

Limitless configurations

The Axis Buffet Collection brings a clean, structured aesthetic to any buffet setup, inspired by the linear elegance its risers create. Designed for height and versatility, Spire Risers add dramatic elevation with three height options, maximising vertical space while conserving tabletop surface. The central Pivot Risers offer a functional core to the collection, accommodating all gastronorm-sized tiles and baskets, and are available in three heights to add depth and dimension to any presentation. With limitless configurations, the Axis Buffet Collection adapts effortlessly to meet every display need, bringing style and functionality to every setting.

Riser finish options available



Black (7363)
Non-Stock



Champagne (7364)



Ivory (7365)
Non-Stock

Wood finish options available



Dark Brown (7367)



Onyx (7368)



Blonde (7369)
Non-Stock



Creations Dark Brown GN ¾ Box
7367MW502



Creations Spire Dark Brown
4 Compartment Box
7367MW510

Creations Spire Dark Brown
Rectangular Connector Tile
7367MW503

Creations Spire Dark Brown
Square Tile W Corner Cut Out
7367MW005



Creations Pivot Dark Brown
GN ½ Box
7367MW501

Creations Spire Dark Brown
4 Compartment Box
7367MW510

Creations Spire Dark Brown Square
Tile W Corner Cut Out
7367MW005

D.W. Haber Ice Bin for
Gastronorm Risers
DW08WP6PL



Creations Rectangle Riser Pivot
Champagne GN ½
7364MW336

Creations Pivot Dark Brown GN ½ Tile
7367MW509

Creations Pivot Champagne
Angled Riser GN ½
7364MW354

Creations Pivot Dark Brown GN ½ Box
7367MW501



Creations Rectangle Riser Pivot Champagne
GN ¾
7364MW334

Creations Pivot Dark Brown GN ¾ Tile
7367MW508

Creations Pivot Dark Brown GN ¾ Box
7367MW502

Bormioli Rocco inAlto Uno
Wine Glass
49105Q769

Creations Pivot Champagne
Angled Riser GN ½
7364MW355

Creations Pivot Dark Brown GN ½ Box
7367MW501



Creations Spire Dark Brown Square Top Tile
7367MW504

Creations Spire Dark Brown Square Tile
W Corner Cut Out
7367MW005

Stellite Performance Nyx
Nordic Stack Plate
12050638

Creations Pivot Dark Brown GN 1/4 Box
7367MW500

Creations Spire Dark Brown Square Top Tile
7367MW504

Creations Spire Dark Brown Square Tile W
Corner Cut Out
7367MW005



Creations Pivot Dark Brown GN ¾ Tile
7367MW508

Creations Pivot Dark Brown GN ¾ Box
7367MW502

Steelite Performance Nyx Bowl
12050481

Steelite Performance Amari Pepper
Nordic Tray
12150641

Folio Bryce Black
5762SX001 Teaspoon

Creations Black Double Cereal
Dispenser
7356MW320

Creations Black Insulated Milk
Urn and Base
7354MW311

Steelite Performance
Nyx Bowl
12050481



Creations Spire Dark Brown Square
Top Tile
7367MW504

Creations Spire Dark Brown Square Tile
W Corner Cut Out
7367MW005

Steelite Performance Nyx Stack Plate
12050638

Creations Pivot Dark Brown GN ¼ Box
7367MW500

Creations Spire Dark Brown Rectangular
Connector Tile
7367MW503

Steelite Performance Amari Pepper Bowl
12150482

Creations Spire Dark Brown Square Top Tile
7367MW504

Creations Spire Dark Brown Square Tile W
Corner Cut Out
7367MW005



Creations Spire Dark Brown Square Top Tile
7367MW504

Creations Spire Dark Brown Square Tile W
Corner Cut Out
7367MW005

Bormioli Rocco inAlto Uno Water
49105Q773

Steelite Performance Amari Pepper Nordic Tray
12150641

Steelite Performance Nyx Nordic Coupe Plate
12050631

Steelite Performance Urban FreeStyle Bowl
12080525

Creations Pivot Dark Brown GN ¼ Box
7367MW500

Creations Spire Dark Brown Rectangular
Connector Tile
7367MW503

Bormioli Rocco inAlto Uno Wine Glass
49105Q769

Creations Spire Dark Brown Square Top Tile
7367MW504

Creations Spire Dark Brown Square Tile W
Corner Cut Out
7367MW005

Bormioli Rocco inAlto UNO Water
49105Q773

Steelite Performance Nyx Nordic Coupe Plate
12050631

Steelite Performance Urban FreeStyle Bowl
12080525



Champagne

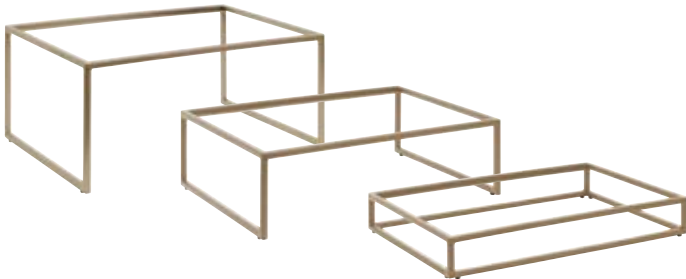

Rectangle Riser Pivot
Champagne GN ¼
7364MW332
55.6 x 35.2 x 22.9cm
(21 7/8 x 13 7/8 x 9")
Box of 1

Rectangle Riser Pivot
Champagne GN ¼
7364MW331
55.6 x 35.2 x 15.2cm
(21 7/8 x 13 7/8 x 6")
Box of 1

Rectangle Riser Pivot
Champagne GN ¼
7364MW330
55.6 x 35.2 x 7.6cm
(21 7/8 x 13 7/8 x 3")
Box of 1

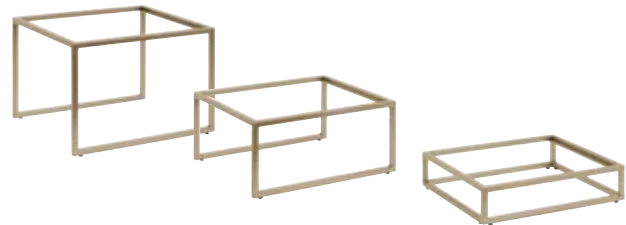

Rectangle Riser Pivot
Champagne GN ½
7364MW338
29.2 x 35.2 x 22.9cm
(11 ½ x 13 7/8 x 9")
Box of 1

Rectangle Riser Pivot
Champagne GN ½
7364MW337
29.2 x 35.2 x 15.2cm
(11 ½ x 13 7/8 x 6")
Box of 1

Rectangle Riser Pivot
Champagne GN ½
7364MW336
29.2 x 35.2 x 7.6cm
(11 ½ x 13 7/8 x 3")
Box of 1



Rectangle Riser Pivot
Champagne GN ¾
7364MW335
55.6 x 18.7 x 22.9cm (21 7/8 x 7 3/8 x 9")
Box of 1

Rectangle Riser Pivot
Champagne GN ¾
7364MW334
55.6 x 18.7 x 15.2cm (21 7/8 x 7 3/8 x 6")
Box of 1

Rectangle Riser Pivot
Champagne GN ¾
7364MW333
55.6 x 18.7 x 7.6cm (21 7/8 x 7 3/8 x 3")
Box of 1

COMING SOON

Axis Buffet Collection **NEW**



Champagne



Angled Riser Pivot Champagne GN 1/4
7364MW352
35.2 x 55.6 x 21.6cm (13 7/8 x 21 7/8 x 8 1/2")
Box of 1



Angled Riser Pivot Champagne GN 1/2
7364MW354
35.2 x 29.2 x 21.6cm (13 7/8 x 11 1/2 x 8 1/2")
Box of 1

Angled Riser Pivot Champagne GN 1/4
7364MW353
35.2 x 55.6 x 11.4cm (13 7/8 x 21 7/8 x 4 1/2")
Box of 1

Angled Riser Pivot Champagne GN 1/2
7364MW355
35.2 x 29.2 x 11.4cm (13 7/8 x 11 1/2 x 4 1/2")
Box of 1



Square Tiered Riser Spire Champagne
7364MW345
24.1 x 24.1 x 72.4cm (9 1/2 x 9 1/2 x 28 1/2")
Box of 1



Square Tiered Riser Spire Champagne
7364MW344
24.1 x 24.1 x 49.5cm (9 1/2 x 9 1/2 x 19 1/2")
Box of 1



Square Tiered Riser Spire Champagne
7364MW343
24.1 x 24.1 x 26.7cm (9 1/2 x 9 1/2 x 10 1/2")
Box of 1



Pivot Dark Brown



Pivot Dark Brown GN 1/4 Tile
7367MW507
55.6 x 35.2 x 1.6cm
(21 7/8 x 13 7/8 x 5/8")
Box of 1

Pivot Dark Brown GN 3/4 Tile
7367MW508
55.6 x 18.7 x 1.6cm
(21 7/8 x 7 3/8 x 5/8")
Box of 1

Pivot Dark Brown GN 1/2 Tile
7367MW509
29.2 x 35.2 x 1.6cm
(11 1/2 x 13 7/8 x 5/8")
Box of 1



Pivot Dark Brown GN 1/4 Box
7367MW500
55.6 x 36.8 x 7.6cm
(21 7/8 x 14 1/2 x 3")
Box of 1

Pivot Dark Brown GN 1/2 Box
7367MW501
29.2 x 35.2 x 7.6cm
(11 1/2 x 13 7/8 x 3")
Box of 1

Pivot Dark Brown GN 3/4 Box
7367MW502
55.6 x 17.5 x 7.6cm
(21 7/8 x 6 7/8 x 3")
Box of 1

Pivot Onyx

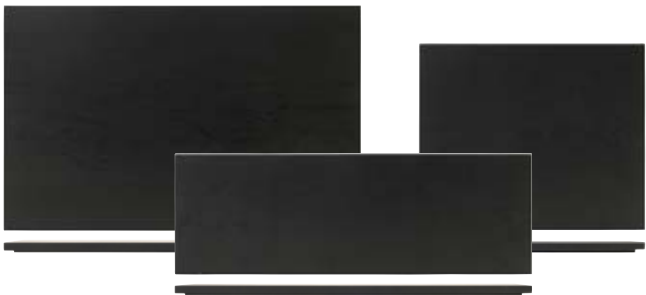

Pivot Onyx GN 1/4 Tile
7368MW507
55.6 x 35.2 x 1.6cm
(21 7/8 x 13 7/8 x 5/8")
Box of 1

Pivot Onyx GN 3/4 Tile
7368MW508
55.6 x 18.7 x 1.6cm
(21 7/8 x 7 3/8 x 5/8")
Box of 1

Pivot Onyx GN 1/2 Tile
7368MW509
29.2 x 35.2 x 1.6cm
(11 1/2 x 13 7/8 x 5/8")
Box of 1



Pivot Onyx GN 1/4 Box
7368MW500
55.6 x 36.8 x 7.6cm
(21 7/8 x 14 1/2 x 3")
Box of 1

Pivot Onyx GN 1/2 Box
7368MW501
29.2 x 35.2 x 7.6cm
(11 1/2 x 13 7/8 x 3")
Box of 1

Pivot Onyx GN 3/4 Box
7368MW502
55.6 x 17.5 x 7.6cm
(21 7/8 x 6 7/8 x 3")
Box of 1

COMING SOON

Axis Buffet Collection **NEW**



Spire Dark Brown



Spire Dark Brown Square
Top Tile
7367MW504
24.1 x 24.1 x 1.6cm
(9 1/2 x 9 1/2 x 5/8")
Box of 1



Spire Dark Brown Square
Tile W Corner Cut Out
7367MW005
24.1 x 24.1 x 1.6cm
(9 1/2 x 9 1/2 x 5/8")
Box of 1



Spire Dark Brown 4
Compartment Box
7367MW510
22.5 x 22.5 x 6.4cm
(8 7/8 x 8 7/8 x 2 1/2")
Box of 1



Spire Dark Brown Rectangular
Connector Tile
7367MW503
61 x 20.6 x 1.6cm (24 x 8 1/8 x 5/8")
Box of 1

Spire Onyx



Spire Onyx Square Top Tile
7368MW504
24.1 x 24.1 x 1.6cm
(9 1/2 x 9 1/2 x 5/8")
Box of 1



Spire Onyx Square Tile
W Corner Cut Out
7368MW505
24.1 x 24.1 x 1.6cm
(9 1/2 x 9 1/2 x 5/8")
Box of 1



Spire Onyx 4
Compartment Box
7368MW510
22.5 x 22.5 x 6.4cm
(8 7/8 x 8 7/8 x 2 1/2")
Box of 1



Spire Onyx Rectangular
Connector Tile
7368MW503
61 x 20.6 x 1.6cm (24 x 8 1/8 x 5/8")
Box of 1



D.W. Haber

Fusion Buffet Ice Cell

The Axis Buffet Collection seamlessly integrates with the Ice Cell, creating a fresh and elevated presentation for cold offerings.



Ice Cell Set

DWFB20ICESET

Includes:

1 Plastic Tray which fits into a Riser,
2 Cooling Blocks and
2 Buffer Pouches.

Gastronorm Platters and Risers sold
separately.

Box of 1

Gastronorm ¼ White Porcelain Tray

DWFBGN1

53 x 32.5cm (20 5/8 x 12 1/2")

Box of 1

Gastronorm ½ White Porcelain Tray

DWFBGN12

26.5 x 32.5cm (10 3/8 x 12 1/2")

Box of 2

Ice Cell Buffer Pouch

DWFBCGNBP

27.6 x 24.1 x 0.6cm (10 7/8 x 9 1/2 x 1/4")

Box of 2

Ice Cell Cooling Block

DWFBCGN12ICE

26.7 x 23.2 x 25.1cm (10 1/2 x 9 1/8 x 9 7/8")

Box of 2

Ice Cell GN ¼ Plastic Tray

DWFBCGNTRAY

52.1 x 32.1 x 4.4cm (20 1/2 x 12 5/8 x 1 3/4")

Box of 1

Pivot Dark Brown GN ¼ Box

7367MW500

55.6 x 36.8 x 7.6cm (21 7/8 x 14 1/2 x 3")

Box of 1

Rectangle Riser Pivot Champagne GN ¼

7364MW330

55.6 x 35.2 x 7.6cm (21 7/8 x 13 7/8 x 3")

Box of 1

Creations
Axis Buffet Collection **NEW**

creations
BY STEELITE





Effortless breakfast service

Creations cereal and milk dispensers bring convenience and style to any breakfast bar. Crafted with durable acrylic bodies, they offer clear visibility of contents, allowing guests to easily select their favourite cereals. Designed for effortless service, these dispensers add a refined touch to any breakfast buffet, while the juice dispensers create a sleek, inviting beverage station that adapts effortlessly to any event.



Juice Dispensers

Milk & Cereal Dispensers



Black Juice Dispenser
7356MW319
20.3 x 26.7 x 60.3cm 11.4L
(8 x 10 ½ x 23 ¾" 3gal)
Handwash Only
Box of 1



Black Juice Dispenser
7356MW318
20.3 x 26.7 x 45.7cm 3.8L
(8 x 10 ½ x 18" 1gal)
Handwash Only
Box of 1



Black Insulated Milk Urn
and Base
7354MW311
30.5 x 17.8 x 53.3cm 2.8L
(12 x 7 x 21" 3qt)
Box of 1



Black Double Cereal Dispenser
7356MW320
43.5 x 28.6 x 69.5cm 3.5L
(17 ½ x 11 ¼ x 27 ¾" 3 ¾qt)
Handwash Only
Box of 1



Fusion Buffet System

Sophistication for any setting

The Fusion Buffet System is a unique and versatile solution for your foodservice presentation. With multi-sized risers, juicers, and baskets, you can mix and match your display with the numerous wood & metal finishes available.

Designed from reclaimed wood, the teak products are environmentally friendly and cost effective, while its natural properties make it resistant to heat, light and moisture. Resin, tempered glass or teak wood tiles can also be used to add new heights, while the 14" risers can be outfitted with universal inserts that make cooking and heating easier.

Finish options available



Ash Grey Teak (AG)



Grey Wash Teak (GW)



Natural Teak (T)



Black Teflon (BK)



Stainless Steel



D.W. Haber
DW396ST9
Serving Tong
22.9cm (9 1/4")

D.W. Haber
Cover Holder
DW396CVRHOLD1
Satin SS Adapter Clip
DWFB14CLIPHOLD1

D.W. Haber
Black Hanging Card Holder for Wood Risers
DW07373HK2BK
9.8cm (L 3 7/8" W 2 3/8")

D.W. Haber
Ash Grey Fusion Buffet Riser Gastronorm
DWFB20127WDAG
58.4 x 38.1 x 18.4cm (L 23" W 15" H 7 1/4")

Creations Chafer Round Brushed Stainless
7352MW301
3.8L (4qts) 38.1 x 31.8 x 12.7cm (L 15" W 12 1/2" H 5")
7352MW300
1.9L (2qts) 30.5 x 25.4 x 12.7cm (L 12" W 10" H 5")

D.W. Haber Ash Grey 3 Piece Riser Set
DWRISERS3WDAG
58.4cm (L 23" W 6") in 3 Heights: 1 1/2", 3 1/2", 5 1/2"



D.W. Haber
Ash Grey Square Riser
DWFB612WDAG
15.2 x 30.5cm (L W 6" H 12")

D.W. Haber
Black Glass Square Tile
DWFBGL12BK
30.5cm (L W 12" H 3/8")

D.W. Haber
Ash Grey Square Riser
DWFB66WDAG
15.2 x 15.2cm (L W 6" H 6")

D.W. Haber
Black Glass Square Tile
DWFBGL6BK
15.2cm (L W 6" H 3/8")

D.W. Haber
Juicer w/Ash Grey
Teak Wood Base
DW12JLWDAG 11.4L (12qt)

D.W. Haber
Drip Tray w/Drainer
DW30045SET
D 13.4cm (5 1/4")

D.W. Haber
Juicer w/Ash Grey
Teak Wood Base
DW07JLWDAG 6.6L (7qt)



Steelite Performance
Vesuvius Coupe Plate
12010567 D 20.25cm (8")

D.W. Haber
Natural Teak Square Riser
DWFB66WDT
15.2 x 15.2cm (L W 6" H 6")

D.W. Haber
Black Glass Square Tile
DWFBGL6BK
15.2cm (L W 6" H 3/8")

D.W. Haber
DW396ST9
Serving Tong 22.9cm (9")

Steelite Performance
Ink Nomad Blue Coupe Plate
17620568
D 15.25cm (6")

D.W. Haber
Black Glass Rectangle Tile
DWFBGL241BK
60.9 x 27.9cm (L 24" W 11" H 3/8")

D.W. Haber
Natural Teak Square Riser
DWFB612WDT
15.2 x 30.5cm (L W 6" H 12")

D.W. Haber
Black Glass Square Tile
DWFBGL6BK
15.2cm (L W 6" H 3/8")

Steelite Performance
Revolution Essence Bowl
17770597
16.5cm 58.5cl (D 6 1/2" H 2 3/8" 20.6oz)



Steelite Performance
Aurora Revolution Bowl
17800481
D 13.5cm (5 1/4") 45.5cl (16oz)

D.W. Haber
Black Glass Rectangle Tile
DWFBGL2407BK
60.9 x 17.8cm (L 24" W 7" H 3/8")
DWFBGL2411BK
60.9 x 27.9cm (L 24" W 11" H 3/8")

D.W. Haber
Natural Teak Square Riser
DWFBG12WDT
15.2 x 30.5cm (L W 6" H 12")

D.W. Haber
Black Glass Square Tile
DWFBGL6BK
15.2cm (L W 6" H 3/8")

D.W. Haber
Black Glass Rectangle Tile
DWFBGL2411BK
60.9 x 27.9cm (L 24" W 11" H 3/8")

D.W. Haber
Natural Teak Square Riser
DWFBG6WDT
15.2 x 15.2cm (L W 6" H 6")

D.W. Haber
Black Glass Square Tile
DWFBGL6BK
15.2cm (L W 6" H 3/8")



Steelite Performance
Urban Coupe Plate
12080567
D 20.25cm (8")

D.W. Haber Rectangle Black HomeStyle Chafer
DW04QCWG8BK
3.8L (L 13 1/4" W 11 1/8" H 4qt)

D.W. Haber
Gastronorm Buffet Riser
DWFB20127WDGW
58.4 x 38.1 x 18.4cm (L 23" W 15" H 7 1/4")

D.W. Haber
Black Hanging Card Holder
for Wood Risers
DW07373HK2BK
9.8cm (L 3 7/8" W 2 3/8")

D.W. Haber
Hammered Serving Tong
DW396ST9
22.9cm (9 1/4")

Steelite Performance
Craft Licorice Coupe Plate
12090568 D 15.25cm (6")

D.W. Haber Square Riser
DWFB612WDGW
15.2 x 30.5cm (L W 6" H 12")

D.W. Haber Black Glass
Square Tile
DWFBGL6BK
15.2cm (L W 6" H 3/8")

D.W. Haber
Square Riser
DWFB66WDGW
15.2 x 15.2cm (L W 6" H 6")

D.W. Haber
Black Glass Square Tile
DWFBGL6BK
15.2cm (L W 6" H 3/8")



Steelite Performance
Taste Bowl
11070633
12.0cm 56.75cl (D 4 3/4" H 3" 20oz)

D.W. Haber
3 Piece Riser Set
DWRISERS3WDGW
58.4cm (L 23" W 6")
in 3 Heights: 1 1/2", 3 1/2", 5 1/2"

D.W. Haber
Divided Round Food Pan
DW06RFP2
38.7cm (D 15 1/4" H 3")
7.5L (2gal)

Steelite Performance
Craft Liquorice Coupe Plate
12090568
D 15.25cm (6")

D.W. Haber
Bakery Split Cover
7345MW150
54.6 x 34.9cm (L 21 1/2" W 13 3/4")

D.W. Haber
Ice Bin for Gastronorm Risers
DW08WP6PL
(L 20 7/8" W 12 3/4" H 6")



D.W. Haber
Gastronorm Buffet Riser
DWFB20127WDT
58.4 x 38.1 x 18.4cm (L 23" W 15" H 7 1/4")
(Fits EL590, EL591)

D.W. Haber Bakery Split Cover
7345MW150
54.6 x 34.9cm (L 21 1/2" W 13 3/4")

D.W. Haber Ice Bin for Gastronorm Risers
DW08WP6PL
(L 20 7/8" W 12 3/4" H 6")

Bormioli Rocco
Ypsilon Carafe
4945Q939 114cl (38 1/2oz)
H 215mm (8 1/2"), Ø 115mm (4 1/2")
Only available in the UK

D.W. Haber Stainless Steel Hanging Card Holder
for Fusion Wood Risers
DW07373HK2SS
9.8cm (L 3 7/8" W 2 3/8")

D.W. Haber
Carrera Resin Square Tile
DWKFB1212CAR 30.5cm (L W 12" H 3/8")

D.W. Haber Black Universal Shelf Holder
for Teak Fusion Risers
DWFBUSHT4A

D.W. Haber
Gastronorm Buffet Riser
DWFB20127WDT
58.4 x 38.1 x 18.4cm (L 23" W 15" H 7 1/4")

D.W. Haber
Ice Cell
DWFB20ICESET
Set Includes 1 Tray, 2 Cooling Blocks and 2 Buffer Pouches
Gastronorm Platter Sold Separately
DWFBGN1
Gastronorm White Rectangle Platter 1/2

D.W. Haber
Stainless Steel Hanging Card Holder for Fusion Wood Risers
DW07373HK2SS
9.8cm (L 3 7/8" W 2 3/8")



D.W. Haber
Angled Square Bread Basket
DWFBWDBASK1ST
35.6cm (L W 14")

D.W. Haber
Stainless Steel Riser
DW073114145SS
35.6 x 12.75cm (L W 14" H 5")

D.W. Haber
Fusion Base Natural Teak
DW07JSTNDWDT



D.W. Haber Round Black HomeStyle Chafer
DW06CWG8BK
 7.5L (L 14" W 3 1/2" H 6" 2gal)

D.W. Haber Square Riser Natural Teak
DWFB147WDT
 35.6 x 17.8cm (L W 14" H 7")

D.W. Haber Black Hanging Card Holder
DW07373HK2BK 9.8cm (L 3 7/8" W 2 3/8")

D.W. Haber Cover Holder
DW396CVRHOLD1 27.7 x 11.4cm (11" x 4 1/2")

Satin SS Adapter Clip
DWFB14CLIPHOLD1

D.W. Haber
 Black Glass Square Tile
DWFBGL12BK
 30.5cm (L W 12" H 3/8")

Folio Bryce
 Long Serving Spoon
5731SX062 27.3cm (10 3/4")

D.W. Haber
 Spoon Rest
DW394SR 13.4cm (5 1/4")

D.W. Haber
 Black Shelf Holder
DWFBUSHT4A

D.W. Haber
 Round Black HomeStyle Chafer
DW04CWG8BK
 30 x 9cm (L 11 1/4" W 3 1/2" H 6")
 3.8L (4qt)

D.W. Haber Induction Range
 1800 Watt
 34.3 x 31.8 x 11.4cm H
 (L 13 1/2" W 12 1/2" H 4 1/2")
DWELIN1800BE2 EU Plug
DWELIN1800BE3 UK Plug

D.W. Haber Black Fusion
 Induction Adapter Ring
DWFB14ADAPBK 35.6cm (14")
 (Required for Induction when
 used with the 14" teak risers)

D.W. Haber Black Hanging Card Holder
DW07373HK2BK
 9.8cm (L 3 7/8" W 2 3/8")



D.W. Haber Divided Round Food Pan
DW06RFP2
38.7cm 7.5L (D 15 1/4" H 3" 2gal)

Folio Bryce Long Serving Spoon
5731SX062 27.3cm (10 3/4")

Folio Bryce Large Tong
5731SX073 25.4cm (10")

D.W. Haber Spoon Rest
DW394SR 13.4cm (5 1/4")

D.W. Haber Rectangle Tile Natural Teak
DWFBWD2411ST
60.9 x 27.9cm (L 24" W 11")

Steelite Performance
Revolution Coupe Plate
17760568 D 15.25cm (6")

D.W. Haber Serving Tong
DW396ST9
22.9cm (9")

Ypsilon Carafe
4945Q412 107.5cl (36 1/2oz)
H 255mm (10"), Ø 102mm (4")
Only available in the UK

Creations Melamine
Slate Rectangle Gastronom Platter
68A415EL593
325 x 265mm (L 12 3/4" W 10 1/2")
68A415EL595
325 x 176mm (L 12 3/4" W 7")



D.W. Haber White Round
Porcelain Food Pan
DW64RFPPOR
30.5cm 3.8L (12" 4qt)

D.W. Haber Square Riser
DWFB145WDAG
35.6 x 12.7cm (L W 14" H 5")

D.W. Haber
Black Card Holder
DW07373HK2BK
9.8cm (L 3 7/8" W 2 3/8")

D.W. Haber Cover Holder
DW396CVRHOLD1
Satin SS Adapter Clip
DWFB14CLIPHOLD1

D.W. Haber
Black Shelf Holder
DWFBUSHT4A

D.W. Haber
Square Riser
DWFB66WDAG
15.2 x 15.2cm
(L W 6" H 6")

D.W. Haber
Black Glass Tile
DWFBGL12BK
30.5cm
(L W 12" H 3/8")

D.W. Haber Black
Glass Tile
DWFBGL6BK
15.2cm
(L W 6" H 3/8")

D.W. Haber
Spoon Rest
DW394SR
13.4cm (5 1/4")

Folio Bryce
Small Tong
5731SX074
17.8cm (7")

D.W. Haber White Round
Porcelain Food Pan
DW64RFPPOR 30.5cm 3.8L (12" 4qt)

D.W. Haber Fusion Buffet Riser Gastronorm
DWFB20127WDAG
58.4 x 38.1 x 18.4cm (L 23" W 15" H 7 1/4")



Steelite Performance
 Craft White FreeStyle Bowl
11550523
 28cm 87.25cl
 (L 11" W 9 1/2" H 3.7oz)

Varick
 Fulton Vintage Copper
5735 18/0

Steelite Performance
 Craft White FreeStyle Bowl
11550525
 13cm 13.6cl (5") (4 1/2oz)

Steelite Performance
 Craft White Rectangle Tray
11550556
 33 x 19cm (L 13" W 7 1/2")

D.W. Haber
 Stackable Bakery Box with
 Acrylic Drawer
DWFBWDBDAG
 (L 14" W 8 1/2" H 8")

D.W. Haber
 Black Glass Rectangle Tile
DWFBGL2411BK
 60.9 x 27.9cm (L 24" W 11" H 3/8")
DWFBGL2407BK
 60.9 x 17.8cm L 24" W 7" H 3/8"

D.W. Haber Square Riser
DWFB147WDAG
 35.6 x 17.8cm (L W 14" H 7")

D.W. Haber Square Flat Basket
DWFBWDBASK2SAG
 35.6cm (L W 14")



Ash Grey Teak



Stackable Bakery Box w/ Acrylic Drawer
DWFBWDBDAG
 36.2 x 21.6 x 20.3cm (14 1/4 x 8 1/2 x 8")
 Box of 1



Power Cell Cover Up Ash Grey Teak
DWFB1513WDAG
 42.8 x 38.1 x 9.5cm (16 7/8 x 15 x 3 3/4")
 Box of 1



Gastronorm 1/2 Buffet Riser
DWFB20127WDAG
 58.4 x 38.1 x 18.4cm (23 x 15 x 7 1/4")
 Fits EL590, EL591
 Box of 1



Square Riser
DWFB147WDAG
 35.6 x 17.8cm (14 x 7")
 Box of 1



Square Riser
DWFB145WDAG
 35.6 x 12.7cm (14 x 5")
 Box of 1



Square Riser
DWFB116WDAG
 27.9 x 15.2cm (11 x 6")
 Box of 1



Square Riser
DWFB612WDAG
 15.2 x 30.5cm (6 x 12")
 Box of 1
DWFB66WDAG
 15.2 x 15.2cm (6 x 6")
 Box of 1



Square Angled Basket
DWFBWDBASK1SAG
 35.6cm (14")
 Box of 1



Square Flat Basket
DWFBWDBASK2SAG
 35.6cm (14")
 Box of 1



Rectangle Shelf/Tile
DWFBWD2411SAG
 60.9cm x 27.9cm (24" x 11")
 Box of 1



Square Shelf/Tile
DWFBWD1414SAG 35.6cm (14")
 Box of 1
DWFBWD1212SAG 30.5cm (12")
 Box of 1
DWFBWD1111SAG 27.9cm (11")
 Box of 1
DWFBWD66SAG 15.2cm (6")
 Box of 1



3 Piece Riser Set
DWRISERS3WDAG
 58.4cm (23 x 6")
 in 3 Heights: 1 1/2", 3 1/2", 5 1/2"
 Box of 1



Juicer w/ Wood Base
DW12JLWDAG 11.4L (12qt)
 Universal stand fits 3 size containers
 Box of 1
DW07JLWDAG 6.6L (7qt)
 Universal stand fits 3 size containers
 Box of 1
DW04JLWDAG 3.8L (4qt)
 Universal stand fits 3 size containers
 Box of 1



Grey Wash Teak



Stackable Bakery Box w/ Acrylic Drawer
DWFBWDBDGW
 36.2 x 21.6 x 20.3cm (14 1/4 x 8 1/2 x 8")
 Box of 1



Power Cell Cover Up Grey Wash Teak
DWFB1513WDGW
 42.8 x 38.1 x 9.5cm (16 7/8 x 15 x 3 3/4")
 Box of 1



Gastronorm 1/2 Buffet Riser
DWFB20127WDGW
 58.4 x 38.1 x 18.4cm (23 x 15 x 7 1/4")
 Fits EL590, EL591
 Box of 1



Square Riser
DWFB147WDGW
 35.6 x 17.8cm (14 x 7")
 Box of 1



Square Riser
DWFB145WDGW
 35.6 x 12.7cm (14 x 5")
 Box of 1



Square Riser
DWFB116WDGW
 27.9 x 15.2cm (11 x 6")
 Box of 1



Square Riser
DWFB612WDGW
 15.2 x 30.5cm (6 x 12")
 Box of 1
DWFB66WDGW
 15.2 x 15.2cm (6 x 6")
 Box of 1



Square Angled Basket
DWFBWDBASK1SGW
 35.6cm (14")
 Box of 1



Square Flat Basket
DWFBWDBASK2SGW
 35.6cm (14")
 Box of 1



Rectangle Shelf/Tile
DWFBWD2411SGW
 60.9cm x 27.9cm (24" x 11")
 Box of 1



Square Shelf/Tile
DWFBWD1414SGW 35.6cm (14")
 Box of 1
DWFBWD1212SGW 30.5cm (12")
 Box of 1
DWFBWD1111SGW 27.9cm (11")
 Box of 1
DWFBWD66SGW 15.2cm (6")
 Box of 1



3 Piece Riser Set
DWRISERS3WDGW
 58.4cm (23 x 6")
 in 3 Heights: 1 1/2", 3 1/2", 5 1/2"
 Box of 1



Juicer w/ Wood Base
DW12JLWDGW 11.4L (12qt)
 Universal stand fits 3 size containers
 Box of 1
DW07JLWDGW 6.6L (7qt)
 Universal stand fits 3 size containers
 Box of 1
DW04JLWDGW 3.8L (4qt)
 Universal stand fits 3 size containers
 Box of 1



Natural Teak



Stackable Bakery Box w/ Acrylic Drawer
DWFBWDBDT
 36.2 x 21.6 x 20.3cm (14 1/4 x 8 1/2 x 8")
 Box of 1



Power Cell Cover Up Natural Teak
DWFB15133WDT
 42.8 x 38.1 x 9.5cm (16 7/8 x 15 x 3 3/4")
 Box of 1



Gastronorm 1/4 Buffet Riser
DWFB20127WDT
 58.4 x 38.1 x 18.4cm (23 x 15 x 7 1/4")
 Fits EL590, EL591
 Box of 1



Square Riser
DWFB147WDT
 35.6 x 17.8cm (14 x 7")
 Box of 1



Square Riser
DWFB145WDT
 35.6 x 12.7cm (14 x 5")
 Box of 1



Square Riser
DWFB116WDT
 27.9 x 15.2cm (11 x 6")
 Box of 1



Square Riser
DWFB612WDT
 15.2 x 30.5cm (6 x 12")
 Box of 1
DWFB66WDT
 15.2 x 15.2cm (6 x 6")
 Box of 1



Square Angled Basket
DWFBWDBASK1ST
 35.6cm (14")
 Box of 1



Square Flat Basket
DWFBWDBASK2ST
 35.6cm (14")
 Box of 1



Rectangle Shelf/Tile
DWFBWD2411ST
 60.9cm x 27.9cm (24" x 11")
 Box of 1



Square Shelf/Tile
DWFBWD1414ST 35.6cm (14")
 Box of 1
DWFBWD1212ST 30.5cm (12")
 Box of 1
DWFBWD1111ST 27.9cm (11")
 Box of 1
DWFBWD66ST 15.2cm (6")
 Box of 1



3 Piece Riser Set
DWRISERS3WDT
 58.4cm (23 x 6")
 in 3 Heights: 1 1/2", 3 1/2", 5 1/2"
 Box of 1



Juicer w/ Wood Base
DW12JLWDT 11.4L (12qt)
 Universal stand fits 3 size containers
 Box of 1
DW07JLWDT 6.6L (7qt)
 Universal stand fits 3 size containers
 Box of 1
DW04JLWDT 3.8L (4qt)
 Universal stand fits 3 size containers
 Box of 1

Juicer Stand Natural Teak Wood Base
 with Stainless Steel Nest
DW07JSTNDWDT Box of 1



Black Teflon Risers

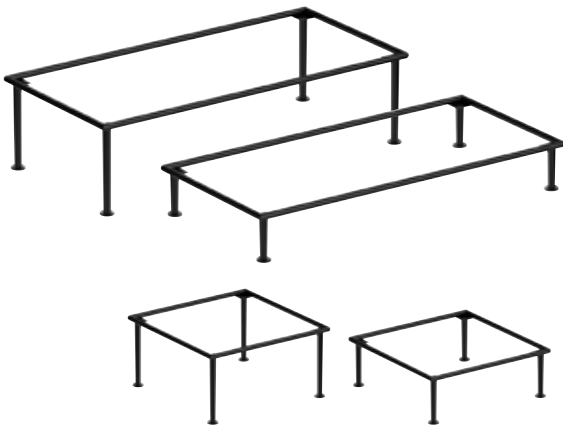

Rectangle Riser Black
DW073124116BK
 61 x 28 x 15.25cm (24 x 11 x 6")
 Box of 1
DW073124113BK
 61 x 28 x 7.6cm (24 x 11 x 3")
 Box of 1

Square Riser Black
DW073112126BK
 30.5 x 15.25cm (12 x 6")
 Box of 1
DW073112124BK
 30.5 x 10cm (12 x 4")
 Box of 1

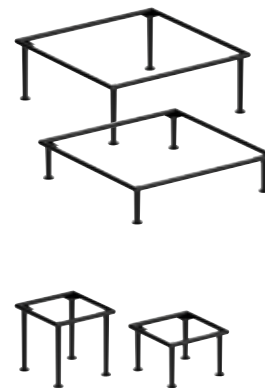

Square Riser Black
DW073114145BK
 35.6 x 12.75cm (14 x 5")
 Box of 1
DW073114143BK
 35.6 x 7.6cm (14 x 3")
 Box of 1

Square Riser Black
DW0731666BK
 15.2 x 15.2cm (6 x 6")
 Box of 1
DW0731664BK
 15.2 x 10cm (6 x 4")
 Box of 1

Polished Stainless Steel Risers

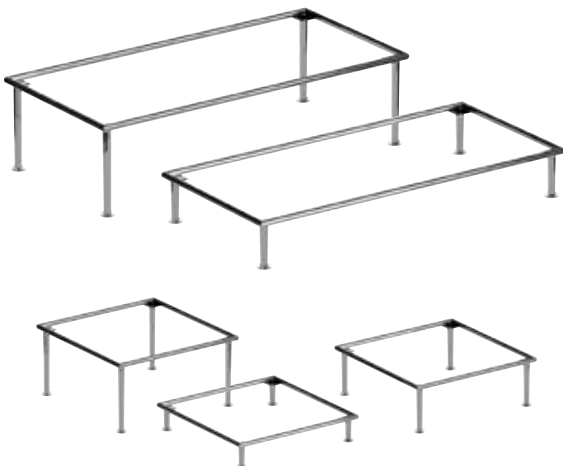

Rectangle Riser Polished SS
DW073124116SS
 61 x 28 x 15.25cm (24 x 11 x 6")
 Box of 1
DW073124113SS
 61 x 28 x 7.6cm (24 x 11 x 3")
 Box of 1

Square Riser Polished SS
DW073112126SS
 30.5 x 15.25cm (12 x 6")
 Box of 1
DW073112124SS
 30.5 x 10cm (12 x 4")
 Box of 1
DW073112122SS
 30.5 x 5cm (12 x 2")
 Box of 1

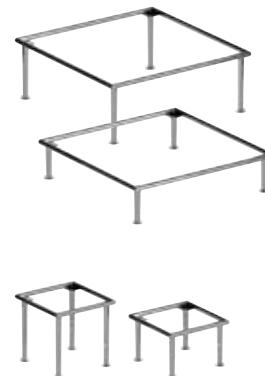

Square Riser Polished SS
DW073114145SS
 35.6 x 12.75cm (14 x 5")
 Box of 1
DW073114143SS
 35.6 x 7.6cm (14 x 3")
 Box of 1

Square Riser Polished SS
DW0731666SS
 15.2 x 15.25cm (6 x 6")
 Box of 1
DW0731664SS
 15.2 x 10cm (6 x 4")
 Box of 1



**Resin Tiles
& Shelves**

Resin tiles are durable, non-absorbent, and food and dishwasher safe.



**Wood Tiles
& Shelves**

Durable teak wood



**Glass Tiles
& Shelves**

Tempered glass

Elevate your buffet presentation

The perfect addition to the Fusion Buffet System are the black Teflon and stainless steel square and rectangle risers. These multi-sized, elevated frames offer beauty and height for your presentation, and are presented with interchangeable inserts in resin, teak wood and tempered glass.



Resin Tiles & Shelves



Square Shelf/Tile Grey Marble Resin
DWKFB1414GM 35.6cm (14 x 3/8")
 Box of 1
DWKFB1212GM 30.5cm (12 x 3/8")
 Box of 1
DWKFB66GM 15.2cm (6 x 3/8")
 Box of 1

Shelf/Tile Grey Marble Resin
DWKFB2411GM
 60.9 x 27.9cm (24 x 11 x 3/8")
 Box of 1



Square Shelf/Tile Carrera Resin
DWKFB1414CAR 35.6cm (14 x 3/8")
 Box of 1
DWKFB1212CAR 30.5cm (12 x 3/8")
 Box of 1
DWKFB66CAR 15.2cm (6 x 3/8")
 Box of 1

Shelf/Tile Carrera Resin
DWKFB2411CAR
 60.9 x 27.9cm (24 x 11 x 3/8")
 Box of 1

Glass Tiles & Shelves



Square Shelf/Tile Black Glass
DWFBGL14BK 35.6cm (14 x 3/8")
 Box of 2
DWFBGL12BK 30.5cm (12 x 3/8")
 Box of 2
DWFBGL6BK 15.2cm (6 x 3/8")
 Box of 2

Rectangle Shelf/Tile Black Glass
DWFBGL3611BK
 91.4 x 27.9cm (36 x 11 x 3/8") Box of 2
DWFBGL3607BK
 91.4 x 17.8cm (36 x 7 x 3/8") Box of 2
DWFBGL2411BK
 60.9 x 27.9cm (24 x 11 x 3/8") Box of 2
DWFBGL2407BK
 60.9 x 17.8cm (24 x 7 x 3/8") Box of 2

Wood Tiles & Shelves



Ash Grey Teak Square Shelf/Tile
DWFBWD1414SAG 35.6cm (14") Box of 1
DWFBWD1212SAG 30.5cm (12") Box of 1
DWFBWD1111SAG 27.9cm (11") Box of 1
DWFBWD66SAG 15.2cm (6") Box of 1

Ash Grey Teak Rectangle Shelf/Tile
DWFBWD2411SAG
 60.9cm x 27.9cm (24" x 11")
 Box of 1



Grey Wash Teak Square Shelf/Tile
DWFBWD1414SGW 35.6cm (14") Box of 1
DWFBWD1212SGW 30.5cm (12") Box of 1
DWFBWD1111SGW 27.9cm (11") Box of 1
DWFBWD66SGW 15.2cm (6") Box of 1

Grey Wash Teak Rectangle Shelf/Tile
DWFBWD2411SGW
 60.9cm x 27.9cm (24" x 11")
 Box of 1



Natural Teak Square Shelf/Tile
DWFBWD1414ST 35.6cm (14") Box of 1
DWFBWD1212ST 30.5cm (12") Box of 1
DWFBWD1111ST 27.9cm (11") Box of 1
DWFBWD66ST 15.2cm (6") Box of 1

Natural Teak Rectangle Shelf/Tile
DWFBWD2411ST
 60.9cm x 27.9cm (24" x 11")
 Box of 1



Use DWFBUSHT4A Universal Shelf Holders to connect Fusion Teak Tiles to risers.



 Ambient Buffet

Bakery Split Cover
7345MW150
 L 21½" W 13¾"

Slate Rectangle Platter
68A415EL591 L 21" W 12¾"
 Available in: Slate, Driftwood & Craft White



 Cold Buffet

DWFBGN1
 Ice Cell Gastronorm
 White Rectangle Platter ⅓

DWFB20ICESET
 Ice Cell Set
 Set Includes 1 Tray,
 2 Cooling Blocks and
 2 Buffer Pouches

**Ice Bin for
 Gastronorm Risers**
DW08WP6PL
 L 20⅞" W 12¾" H 6"

Fusion Buffet Riser Gastronorm
DWFB20127WDAG
 Ash Grey Teak L 23" W 15" H 7¼"
 Available in three finishes:
 Grey Wash, Ash Grey & Natural Teak





Ice Cell

The perfect solution for keeping your buffet food fresh and chilled for extended periods! This innovative chilling system is designed to keep food cold for at least 3 hours, ensuring freshness and quality. Keeping food at the right temperature is crucial to prevent bacterial growth and maintain its taste and texture. The D.W. Haber Ice Cell is specifically designed to fit the standard and low profile Fusion Gastronorm risers, available in 3 finishes: Ash Grey, Grey Wash, and Natural Teak wood.



1. Store the cooling blocks in the freezer overnight for the best results.



2. Place the cooling blocks in the BPA free tray, and set the temperature equalisers on top of the blocks to maintain even cold distribution.



3. Add the porcelain Gastronorm platter and enjoy chilled food for at least 3 hours.



Ice Cell Set
DWFB20ICESET

Includes:
 1 Plastic Tray which fits into a Riser,
 2 Cooling Blocks and
 2 Buffer Pouches.
 Gastronorm Platters and Risers sold separately.
 Box of 1

Gastronorm 1/2 White Porcelain Tray
DWFBGN1
 53 x 32.5cm (20 7/8 x 12 1/2")
 Box of 1

Gastronorm 1/2 White Porcelain Tray
DWFBGN12
 26.5 x 32.5cm (10 3/8 x 12 1/2")
 Box of 2

Ice Cell Buffer Pouch
DWFBGCBP
 27.6 x 24.1 x 0.6cm (10 7/8 x 9 1/2 x 1/4")
 Box of 2

Ice Cell Cooling Block
DWFBGNI2ICE
 26.7 x 23.2 x 25.1cm (10 1/2 x 9 1/8 x 9 7/8")
 Box of 2

Ice Cell GN1/2 Plastic Tray
DWFBGNTRAY
 52.1 x 32.1 x 4.4cm (20 1/2 x 12 5/8 x 1 3/4")
 Box of 1

Gastronorm 1/2 Buffet Riser
 58.4 x 38.1 x 18.4cm (23 x 15 x 7 1/4")
 Fits EL590, EL591
 Box of 1

DWFB20127WDAG Ash Grey Teak
DWFB20127WDGW Grey Wash Teak
DWFB20127WDT Natural Teak



 Fusion Hot Buffet Inserts & Accessories



Induction Warmer 300w/220V
34.3 x 31.8 x 11.4cm
(13 1/2 x 12 1/2 x 4 1/2") Adapter
required with induction when
using a riser

DWELIN300BE2 EU Plug

Box of 1

DWELIN300BE3 UK Plug

Box of 1



Induction Cooker 1800 Watt
1800w/220V
34.3 x 31.8 x 11.4cm
(13 1/2 x 12 1/2 x 4 1/2") Adapter
required with induction when
using a riser

DWELIN1800BE2 EU Plug

Box of 1

DWELIN1800BE3 UK Plug

Box of 1



Fusion Induction Adapter Black
DWFB14ADAPBK
35.6cm (14") Required for
induction when used with the
14" teak risers
Box of 1



Power Cell Cordless Induction
Range Patent-Pending 220V
EU & UK Plug

DWELINPCE2E3
37.1 x 33 x 7.6cm (14 5/8 x 13 x 3")
Box of 1

Power Cell Travel Case

DWELINPCCASE
48.3 x 40.3 x 18.1cm
(19 x 15 7/8 x 7 1/8") Box of 1



Power Cell Cover Up
42.8 x 38.1 x 9.5cm
(16 7/8 x 15 x 3 3/4")
Box of 1

DWFB15133WDAG

Ash Grey Teak

DWFB15133WDGW

Grey Wash Teak

DWFB15133WDT

Natural Teak



Square Grill Stainless Steel
DWFB11GRILL
27.9cm (11")
Box of 1



Fusion Buffet Inserts & Accessories



Attaches to Fusion Metal Risers,
Wood Risers & Heater Stands

Fusion Ambient Buffet Inserts & Accessories

Fusion Cold Buffet Inserts & Accessories



Bakery Split Cover
7345MW150
54.6 x 34.9cm (21 1/2 x 13 3/4")
Fits EL590, EL591, DW08WP6PL
Box of 1



Ice Bin for Gastronom Risers
DW08WP6PL
50.8 x 30.5 x 15.2cm (20 7/8 x 12 3/4 x 6")
Fits DWFB20127
Box of 1

Additional Fusion Buffet Inserts & Accessories



Free Standing Satin Universal
Cover Holder
DW396CVRHOLD1
27.7 x 11.4cm (11 x 4 1/2")
Box of 6



Satin Stainless Steel Adapter
Clip For Universal Cover Holder
DWFB14CLIPHOLD1
Used to attach cover holder to
Wood Fusion Risers
Box of 6



Utensil Rest Stainless Steel
DWFBREST2
24.1 x 11.7cm (9 1/2 x 4 5/8")
Fits Teak Risers
Box of 6



Utensil Rest Stainless Steel
DWFBREST
24.1 x 11.7cm (9 1/2 x 4 5/8")
Fits Metal Fusion Risers
Box of 6



Black Universal Shelf Holder
for Teak Fusion Risers
DWFBUSHT4A
Includes 4 pieces.
Fits all teak risers and holds
glass, resin or wood tiles
Box of 1



Hanging Card Holder
Stainless Steel
DW07373HKSS
9.8cm (3 7/8 x 2 3/8")
Fits Metal Fusion Risers
Box of 6



Hanging Card Holder
Black
DW07373HK2BK
9.8cm (3 7/8 x 2 3/8")
Fits Teak Risers
Box of 6



Hanging Card Holder
Stainless Steel
DW07373HK2SS
9.8cm (3 7/8 x 2 3/8")
Fits Teak Risers
Box of 6



Spoon Rest
DW394SR
13.4cm (5 1/4 x 3 3/4 x 3")
Box of 2



Drip Tray w/ Drainer
DW30045SET
13.4cm (5 1/4")
Box of 2



Visual Display

Creating a visually appealing buffet display is crucial in the foodservice industry, as it is the first impression that guests will have of the food & service. At Steelite-Utopia, we provide professional caterers with the right tools to create the perfect presentation every time.



Elevate your buffet presentation

Bring your buffet to new heights with the wood offerings from Creations Buffet. Available in various shapes and sizes, these platforms offer a unique and exciting solution for your foodservice presentation. Designed from acacia wood, the serving boards are strong, durable, and resistant to staining, while providing a look that will attract the eyes of your guests every time.



Oval Faceted Acacia Board
6525TW321
71.1 x 30.5 x 5cm H (28 x 12 x 2" H)
Box of 2



Square Faceted Acacia Board
6525TW322
38.1 x 5cm H (15 x 2" H)
Box of 2



Olive Wood from the olive tree has high antibacterial properties making it an excellent wood to use with food. Each piece of olive wood will vary in size and shape as these are natural products, sizes and images are given as indications.



Handled Board
JMP986 40cm (15.75")
Box of 6



Rustic Oval Platter
JMP988 40cm (15.75")
Box of 6



Board with Juice Groove
JMP991 35 x 17cm (14 x 6.75")
Box of 6



Narrow Boat
JMP008 41cm (16")
Box of 6



Rustic Platter
JMP979 25.5cm (10")
Box of 6



Rustic Oval Bowls
JMP004 24.5 x 17cm (9.75 x 6.75")
Box of 6



Rustic Oval Bowls
JMP003 19.5 x 13.5cm (7.5 x 5.5")
Box of 6



Round Bowl
JMP001 12cm (4.75")
Box of 6



Acacia Presentation Stand to hold 3 Serving Dishes

JMP963 42 x 18cm (16.5 x 7")

Box of 6

Will hold:

MH0009 Cast Iron Round Casserole 10cm (4")

MH7006 Cast Iron Calico Round Casserole 10cm (4")

M14018 Gourmande Midnight Round Casserole 10cm (4")

M14019 Gourmande Flame Round Casserole 10cm (4")



Reversible Acacia Board with Indents

JMP977 41 x 15cm (16.25 x 6")

Box of 6

Acacia Presentation Stand to hold 3 Serving Dishes, Indents can hold a selection of items including:

M10001 Ribbed Ramekin

F91016 Copper Pan

M15006 Tapas Ramekin



Acacia Small Crate

JMP828

22 x 16 x 5.75cm (8.75 x 6.25 x 2.25")

Box of 6



Acacia Medium Crate

JMP814

26 x 20 x 5.75cm (10 x 7.5 x 2.25")

Box of 6



Acacia Large Crate

JMP827

32 x 22 x 9cm (12.5 x 8.5 x 3.5")

Box of 1



Acacia Serving Box

JMP830

24 x 16 x 4cm (9.5 x 6.5 x 1.5")

Box of 6



Chicago Handled Acacia Board with Leather Strap

JMP969 30 x 23cm (11.75 x 9")

Box of 6



Chicago Handled Acacia Board with Leather Strap

JMP970 24 x 18cm (9.5 x 7")

Box of 6



Acacia Rolled Edged Tray

JMP956 34 x 22cm (13 x 8.5")

Box of 6



Acacia Serving Board

JMP975 24 x 16.5cm (9.5 x 6.5")

Box of 6



Acacia Wood Platter/Pizza Board

JMP940 30cm (12")

Box of 6



Acacia Wood Serving Board

JMP937 42 x 14cm (17 x 5.5")

Box of 6

Discovery & Darwin

Our Discovery & Darwin boards have a rustic, authentic and raw feel about them, with some of the boards displaying a rope tie for added texture and offering a practical use. The boards are cut from one piece of wood, making them extremely strong with no chance of splitting.



Discovery Acacia Board

JMP051 30.5cm (12")

Box of 6



Darwin Acacia Board

JMP056 30cm (11.75")

Box of 6



Darwin Acacia Board

JMP055 20cm (7.5")

Box of 6



Milano Bamboo Pizza Paddle
JMP968 Holds a 15" Pizza
40cm (15.75")
Box of 6



Milano Bamboo Pizza Paddle
JMP967 Holds a 12" Pizza
32cm (12.5")
Box of 6

Milano Pizza Paddles are the perfect way to serve pizza, ideal for sharing, creating an authentic Italian presentation.



Crafted from one piece of Ash, its washed appearance makes for the ideal casual dining presentation.



Dakota Handled Ash Board
JMP823 36cm (14")
Box of 6

Slate Presentation

Slate offers a contemporary and stylish presentation platform, adding a natural texture to the dinner table. Utopia's extensive collection offers every size and shape variation from Extra Large Rectangles to Round Slate Platters, down to an individual slate square. All come with protective pads on the bottom of each item to protect table tops.



Square Slate Platter
CT0028 28cm (11")
Box of 6



Large Rectangular Slate Platter
CT0029 30 x 22cm (12 x 8.5")
Box of 6



Small Rectangular Slate Platter
CT0030 26 x 13cm (10 x 5")
Box of 6



Rectangular Slate Platter
CT0046 35 x 23cm (14 x 9")
Fits with JMP821
Box of 6



Extra Large Slate Platter
CT0042 53 x 32cm (21 x 12.75")
Box of 1



Round Slate Platter
CT0031 30cm (12")
Box of 6



Ovoid Slate Platter
CT0039 22 x 18cm (8.5 x 7")
Box of 6



3 Tier Slate Platter
CT0041
30, 25, 20cm (12, 10, 8")
Box of 1



As Street Food moves inside these stands offer perfect presentation, from Tacos and Baos to Dogs and Gyros. Dig In.



Black Double Street Food Stand
F91176 13.5 x 10cm (5.5 x 4")
Box of 12



Black Triple Street Food Stand
F91177 21 x 10cm (8.25 x 4")
Box of 12



Double Street Food Stand
F91170 13.5 x 10cm (5.5 x 4")
Box of 12

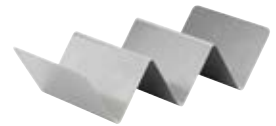

Triple Street Food Stand
F91172 21 x 10cm (8.25 x 4")
Box of 12



Copper Double Street Food Stand
F91171 13.5 x 10cm (5.5 x 4")
Box of 12



Copper Triple Street Food Stand
F91173 21 x 10cm (8.25 x 4")
Box of 12



Chafers & Cookware

Create a visual impact by separating the ordinary from the extraordinary in buffet. Steelite-Utopia shares your passion for excellence in catering through superior offerings in chafers and cookware.

This section highlights all induction-capable and traditional fuel units.



Steelite Performance
Ink Nomad Blue
17620566
Coupe Plate
D 25.25cm (10")

Hollowick
HWEZ638
Easy Heat 6-3-8 Hour Chafing Fuel



Creations Homestyle Chafer
7353MW301
Round Antique Brushed Bronze
3.8L (4qts)
38.1 x 31.8 x 12.7cm H
(15 x 12 ½ x 5" H)

Steelite Performance
Ink Nomad Blue
17620569
Coupe Bowl
25.25cm 120.25cl
(D 10" H 1 ½" 42.3oz)

Steelite Performance
Aurora Vesuvius
17820481
Bowl
13.5cm 45.5cl (D 5 ¼" 16oz)



Backed by D.W. Haber's 100-year warranty

Elevate your buffet service with D.W. Haber's Hinged Chafers. With the capability to work on induction, heater stands, or chafers frames, these chafing dishes feature a clever, patented hinge that will stop the lid in any position, making it the ultimate choice for foodservice. These vessels are available with a solid or full glass lid, and have a unique built-in condensation system that returns condensation back in to the water pan.



Induction



Round Induction Chafer Full Glass Lid
DW06WGH7SS
 50.8cm 7.5L (20 x 16 x 6" 2gal)
 Box of 1
DW04WGH7SS
 40.6 x 33 x 15.2cm 3.8L (16 x 13 x 6" 4qt)
 Box of 1

Food Pans



Food Pan
DW64RFP
 30.2 x 7cm 3.8L (11 7/8 x 2 3/4" 4qt)
 For 3.8L/4qt Round
 Box of 1
DW06RFP4
 38.7 x 7.6cm 7.5L (15 1/4 x 3" 2gal)
 For 7.5L/2gal Round
 Box of 1



Divided Food Pan
DW64RFP2
 30.5 x 7.6cm 3.8L (12 x 3" 4qt)
 For 3.8L/4qt Round
 Box of 1
DW06RFP2
 38.7 x 7.6cm 7.5L (15 1/4 x 3" 2gal)
 For 7.5L/2gal Round
 Box of 1



White Porcelain Food Pan
DW64RFPOR
 30.5 x 7cm 3.8L (12 x 2 3/4" 4qt)
 For 3.8L/4qt Round
 Box of 1
DW06RFP4POR
 38.7 x 7.6cm 7.5L (15 1/4 x 3" 2gal)
 For 7.5L/2gal Round
 Box of 1



Black Porcelain Food Pan
DW64RFPORBK
 30.5 x 7cm 3.8L (12 x 2 3/4" 4qt)
 For 3.8L/4qt Round
 Box of 1



Chafing dishes at a phenomenal price point

We are pleased to bring hydraulic closing chafing dishes to the Creations collection. Each chafer has a conveniently large glass view in the lid to increase visibility of the food. This feature allows for fewer opens, thus keeping the heat in and the food remains at proper serving temperature. Additionally, the easy-to-remove hydraulic lid closes on its own to ensure that food is kept safe and covered during service. Great for any buffet display, these chafers are induction capable and perfectly priced for even the most value-conscious operators.



INDUCTION

Creations

Hydraulic Chafers

creations
BY STEELITE



Round Chafing Dish
7351MW102
 47.6 x 42.5 x 19cm 9.1L
 (18 3/4 x 16 3/4 x 7 1/2" 2gal)
 Box of 1
 Round Chafing Dish Stand
7351MW103
 30.4 x 39.3 x 16.5cm (12 x 15 1/2 x 6 1/2")
 Box of 1



Rectangular Chafing Dish w/ Stand
7351MW100
 57.2 x 43.2 x 29.8cm 7.6L
 (22 1/2 x 17 x 11 3/4" 8qt)
 Box of 1



Square Chafing Dish
7351MW104
 38.7 x 43.2 x 17.1cm 5.7L
 (15 1/4 x 17 x 6 3/4" 6qt)
 Box of 1
 Square Chafing Dish Stand
7351MW105
 32.4 x 31.1 x 16.5cm (12 3/4 x 12 1/4 x 6 1/2")
 Box of 1

Pair with Hollowick Chafing Fuels.
HWEZ425 Easy Heat 4-2-5 Hour

Food Pans



Food Pan
DW06RFP4
 38.7 x 7.6cm 7.5L (15 1/4 x 3" 2gal)
 For 7.5L/2gal Round
 Box of 1



Divided Food Pan
DW06RFP2
 38.7 x 7.6cm 7.5L (15 1/4 x 3" 2gal)
 For 7.5L/2gal Round
 Box of 1



Rectangular Food Pan
DW08FP
 54.6 x 33 x 7cm 7.5L
 (21 1/2 x 13 x 2 3/4" 8qt)
 For 7.5L/2 gal Rectangle Chafer
 Box of 1



Square Chafing Dish Food Pan
7351MW108
 32.4 x 35.6 x 6.4cm 5.7L
 (12 3/4 x 14 x 2 1/2" 6qt)
 For 6qt Square Chafer
 Box of 1



White Porcelain Food Pan
DW06RFP4POR
 38.7 x 7.6cm 7.5L (15 1/4 x 3" 2gal)
 For 7.5L/2gal Round
 Box of 1

All chafers include a stainless steel food pan.
 D=Diameter L=Length W=Width H=Height • All products are measured at max capacity (oz).



Proprietary Teflon-coated stainless steel

The lightweight Homestyle induction chafers are your go-to vessels for fuel or induction heating. Comprised of stainless steel or coated in black, white or red/black Teflon, these chafing dishes include a food pan, and are chip and scratch resistant. More so, the rectangle chafers have a built-in lid holder for convenient buffet service.



D.W. Haber

Homestyle Chafers



Round Chafers Black
DW06CWG8BK
43.8 x 38.1 x 15.2cm 7.5L
(17 1/4 x 15 x 6" 2gal)
Box of 1



Round Chafers Black
DW04CWG8BK
36.2 x 30.5 x 17.1cm 3.8L
(14 1/4 x 12 x 6 3/4" 4qt)
Box of 1



Round Chafers Black
DW02CWG8BK
29.2 x 24.1 x 14.6cm 1.9L
(11 1/2 x 9 1/2 x 5 3/4" 2qt)
Box of 1



Rectangle Chafers Black
DW04QCW8BK
39.4 x 27.9 x 20.3cm 3.8L
(15 1/2 x 11 x 8" 4qt)
Box of 1



Round Chafers Red/Black
DW02CWG8RD2
29.2 x 24.1 x 14.6cm 1.9L
(11 1/2 x 9 1/2 x 5 3/4" 2qt)
Box of 1



Rectangle Chafers Red/Black
DW04QCW8RD2
39.4 x 27.9 x 20.3cm 3.8L
(15 1/2 x 11 x 8" 4qt)
Box of 1



Round Chafers White
DW02CWG8WT
29.2 x 24.1 x 14.6cm 1.9L
(11 1/2 x 9 1/2 x 5 3/4" 2qt)
Box of 1

Food Pans



Food Pan
DW64RFP
30.2 x 7cm 3.8L (11 7/8 x 2 3/4" 4qt)
For 3.8L/4qt Round
Box of 1
DW06RFP4
38.7 x 7.6cm 7.5L (15 1/4 x 3" 2gal)
For 7.5L/2gal Round
Box of 1



Divided Food Pan
DW64RFP2
30.5 x 7.6cm 3.8L (12 x 3" 4qt)
For 3.8L/4qt Round
Box of 1
DW06RFP2
38.7 x 7.6cm 7.5L (15 1/4 x 3" 2gal)
For 7.5L/2gal Round
Box of 1



White Porcelain Food Pan
DW64RFPPOPOR
30.5 x 7cm 3.8L (12 x 2 3/4" 4qt)
For 3.8L/4qt Round
Box of 1
DW06RFP4POPOR
38.7 x 7.6cm 7.5L (15 1/4 x 3" 2gal)
For 7.5L/2gal Round
Box of 1



Black Porcelain Food Pan
DW64RFPPOPORBK
30.5 x 7cm 3.8L (12 x 2 3/4" 4qt)
For 3.8L/4qt Round
Box of 1



Serving food in style

Create an inviting and cosy presentation on your buffet with Homestyle Chafers from Creations. Available in brushed stainless steel and bronze finishes, these unique vessels look like cookware you'd use at home, but have the functionality of a high-volume chafing dish at a great price point. Safe for the oven, freezer or on induction, the Homestyle Chafers are also dishwasher safe, making cleanup quick and easy.



INDUCTION

Creations

Homestyle Chafers

creations
BY STEELITE



Brushed Stainless



Chafers Round
7352MW302
45.7 x 40 x 14cm 7L
(18 x 15 3/4 x 5 1/2" 2gal)
Box of 1



Chafers Round
7352MW301
38.1 x 31.8 x 12.7cm 3.8L
(15 x 12 1/2 x 5" 4qt)
Box of 1



Chafers Round
7352MW300
30.5 x 25.4 x 12.7cm 1.9L
(12 x 10 x 5" 2qt)
Box of 1



Chafers Rectangular
7352MW303
41.9 x 27.3 x 16.5cm 3.8L
(16 1/2 x 10 3/4 x 6 1/2" 4qt)
Box of 1



Chafers Round Soup
7352MW304
38.1 x 31.8 x 13.3cm 5.2L
(15 x 12 1/2 x 5 1/4" 5 1/2qt)
Box of 1

Antique Brushed Bronze



Chafers Round
7353MW302
45.7 x 40 x 14cm 7L
(18 x 15 3/4 x 5 1/2" 2gal)
Box of 1



Chafers Round
7353MW301
38.1 x 31.8 x 12.7cm 3.8L
(15 x 12 1/2 x 5" 4qt)
Box of 1



Chafers Round
7353MW300
30.5 x 25.4 x 12.7cm 1.9L
(12 x 10 x 5" 2qt)
Box of 1



Chafers Rectangular
7353MW303
41.9 x 27.3 x 16.5cm 3.8L
(16 1/2 x 10 3/4 x 6 1/2" 4qt)
Box of 1



Chafers Round Soup
7353MW304
38.1 x 31.8 x 13.3cm 5.2L
(15 x 12 1/2 x 5 1/4" 5 1/2qt)
Box of 1

Food Pans



Food Pan
DW64RFP
30.2 x 7cm 3.8L (11 7/8 x 2 3/4" 4qt)
For 3.8L/4qt Round
Box of 1
DW06RFP4
38.7 x 7.6cm 7.5L (15 1/4 x 3" 2gal)
For 7.5L/2gal Round
Box of 1



Divided Food Pan
DW64RFP2
30.5 x 7.6cm 3.8L (12 x 3" 4qt)
For 3.8L/4qt Round
Box of 1
DW06RFP2
38.7 x 7.6cm 7.5L (15 1/4 x 3" 2gal)
For 7.5L/2gal Round
Box of 1



White Porcelain Food Pan
DW64RFP4POR
30.5 x 7cm 3.8L (12 x 2 3/4" 4qt)
For 3.8L/4qt Round
Box of 1
DW06RFP4POR
38.7 x 7.6cm 7.5L (15 1/4 x 3" 2gal)
For 7.5L/2gal Round
Box of 1



Black Porcelain Food Pan
DW64RFP4PORBK
30.5 x 7cm 3.8L (12 x 2 3/4" 4qt)
For 3.8L/4qt Round
Box of 1

All chafers include a stainless steel food pan.



Rustic meets modern

Introducing the first ever Homestyle cast iron chafer. With the rustic appeal of cast iron, these vessels feature a food and water pan concept that keeps your food from drying out, and work perfectly with either fuel or induction.



Homestyle Cast Iron Chafers



Cast Iron Dutch Oven Red w/ Black Knob (w/o Food Pan)
DWG4R
40.6cm 4.7L (16 x 12 x 6 1/2" 5qt)
4.7L/5qt w/o Food Pan
Box of 1



Cast Iron Dutch Oven Black w/ Black Knob (w/o Food Pan)
DWG4
40.6cm 4.7L (16 x 12 x 6 1/2" 5qt)
4.7L/5qt w/o Food Pan
Box of 1



Food Pan
DW64RFP
30.2 x 7cm 3.8L (11 7/8 x 2 3/4" 4qt)
For 3.8L/4qt Round
Box of 1



Divided Food Pan
DW64RFP2
30.5 x 7.6cm 3.8L (12 x 3" 4qt)
For 3.8L/4qt Round
Box of 1



Black Porcelain Food Pan
DW64RFPPORBK
30.5 x 7cm 3.8L (12 x 2 3/4" 4qt)
For 3.8L/4qt Round
Box of 1



White Porcelain Food Pan
DW64RFPPOR
30.5 x 7cm 3.8L (12 x 2 3/4" 4qt)
For 3.8L/4qt Round
Box of 1



Free Standing Satin Universal Cover Holder
DW396CVRHOLD1
27.7 x 11.4cm (11 x 4 1/2")
Box of 6



Satin Stainless Steel Adapter Clip For Universal Cover Holder
DWFB14CLIPHOLD1
Used to attach cover holder to Wood Fusion Risers
Box of 6



Tabletop



Attaches to fusion metal & wood risers



Attaches to 20" & 40" heater stands

Universal Cover Holder



HEPP

Hepp
Chafers



HEPP's traditional manufacturing excellence come together to create an exceptional range of tabletop, buffet, accent pieces and accessories. Manufactured in 18/10 stainless steel or silver, all items have superb durability and inherent strength with a high resistance to staining to ensure a perfect presentation.



Excellent Black & Silver Induction Chafing Dish GN ¼
51471993
58 x 47 x 19cm (22 ¾ x 18 ½ x 7 ½")
Fits 51471996
Box of 1
Excellent Black Chafing Dish Stand GN ¼
51471996
58 x 37 x 17cm (22 ¼ x 14 ½ x 6 ¾")
Fits 51471993
Box of 1



Excellent Black & Gold Induction Chafing Dish GN ¼
51471986
37 x 49 x 19cm (14 ½ x 19 ¾ x 7 ½")
Fits 51471995
Box of 1
Excellent Black Chafing Dish Stand GN ¼
51471995
37 x 40 x 17cm (14 ½ x 15 ¾ x 6 ¾")
Fits 51471986
Box of 1



Excellent Black & Copper Induction Chafing Dish Round
51471983
29 x 19cm (15 ½ x 7 ½")
Fits 51471994
Box of 1
Excellent Chafing Dish Stand Round
51471994
39 x 17cm (15 ½ x 6 ¾")
Fits 51471983
Box of 1



Excellent Induction Chafing Dish GN $\frac{2}{5}$
51471089
36.8 x 45 x 19cm (14.5 x 17.75 x 7.5")
Box of 1
Excellent Induction Chafing Dish Stand
GN $\frac{2}{5}$
51471091
43 x 40 x 24cm (17.25 x 15.75 x 9.5")
Box of 1



Excellent Induction Round Chafing Dish
51471075
39cm (15 $\frac{1}{2}$ " Dia
Box of 1
Excellent Round Chafing Dish Stand
for Induction
51471076
56cm (22") Dia
Box of 1



Excellent Stainless Steel Roll-Top
Chafing Dish GN $\frac{1}{4}$
51471217
70 x 40 x 47cm (27.6 x 15.75 x 18.5")
Box of 1



Excellent Round Roll-Top Chafing Dish
51471364
45 x 48cm H (17.72 x 18.9" H)
Fits Porcelain Insert 30cm (11 $\frac{1}{2}$ "")
Box of 1



Neutral Porcelain Insert GN $\frac{1}{4}$
50161730
53 x 32.5 x 6.5cm (20.9 x 12.8 x 2.56")
Box of 1
Neutral Porcelain Insert GN $\frac{1}{2}$
50161731
27cm x 32.5 x 6.5cm (10.4 x 12.8 x 2.56")
Box of 1



Neutral Porcelain Insert GN $\frac{2}{5}$
50161732
35 x 32.5 x 6.5cm (13.9 x 12.8 x 2.56")
Box of 1



Neutral Porcelain Round Insert
50161680
30 x 7cm H (11 $\frac{3}{4}$ x 2 $\frac{3}{4}$ " H)
Box of 1



Neutral Porcelain Round Divided Insert
50161734
33.5 x 7cm H (13 $\frac{1}{2}$ x 2 $\frac{3}{4}$ " H)
Box of 1



Neutral Insert GN $\frac{1}{4}$
50161594
6.5cm H (2 $\frac{5}{8}$ " H)
Box of 1



Neutral Insert for Chafing Dish $\frac{2}{5}$
51841007
6.5cm H (2 $\frac{5}{8}$ " H)
Box of 1



Neutral Round Insert for Chafing Dish
50161062
33.5cm (3 $\frac{3}{8}$ "")
Box of 1

Inserts



Neutral Utensil Rack
50161077
28 x 12cm (11 x 4 $\frac{3}{8}$ "")
Box of 1



Neutral Fuel Burner Tin
50161029
9.4cm (3 $\frac{5}{8}$ "") Dia
Box of 1



Neutral Burner Holder for Chafing
Dish GN $\frac{1}{4}$
50161402
Box of 1



Neutral Strut
50161597
32.5cm (12 $\frac{1}{2}$ "")
Box of 1

Accessories



Utopia's extensive Cast Iron collection showcases several shapes ideal for oven to table service, from casserole to skillet to wok we have every option covered. With Acacia wood boards available, Cast Iron pieces can be taken straight from the oven to the table.

- Not recommended for Dishwasher
- Ensure completely dry before storing or stacking as items left wet may be prone to rusting.



Round Eared Dish
MH7004 19cm 75.5cl (7.25" 27oz)
Box of 6
Oval Acacia Wood Board
JMP951 25 x 18.5cm (10 x 7.25")
Box of 6



Long Handled Skillet
MH6104 20cm (8")
Box of 6



Round Pan
MH1402 14cm 39cl (5.5" 13.75oz)
Box of 6
Round Acacia Wood Board
JMP805 19cm (7.5") Fits MH1402
Box of 6



Round Pan
MH1406 10cm 12cl (4" 4.25oz)
Box of 6
Round Acacia Wood Board
JMP804 14.2cm (5.5")
Box of 6



Rectangular Eared Dish
MH7002 20cm 43cl (8" 15oz)
Box of 6
Rectangular Acacia Wood Board
JMP947 21 x 16cm (8.25 x 6.25")
Box of 6



Skillet
MH6102 12.5 x 10cm 20cl (5 x 4" 7oz)
Box of 6
Rectangular Acacia Wood Board
JMP800 18cm x 16cm (7 x 6.5")
Box of 6



Square Skillet
MH6101 14cm 41cl (5.5" 14.5oz)
Box of 6
Square Acacia Wood Board
JMP802 19cm (7.5")
Box of 6



Small Oval Casserole
MH1510
12.5 x 9cm 24.5cl (5 x 3.5" 8.25oz)
Box of 6



Round Casserole
MH0009 10cm 26cl (4" 9oz)
Box of 6
Round Acacia Wood Board
JMP804 14.2cm (5.5")
Fits MH0009, MH7006, MH1406
Box of 6



Round Calico Casserole
MH7006 10cm 26cl (4" 9oz)
Box of 6
Round Acacia Wood Board
JMP804 14.2cm (5.5")
Box of 6



Round Casserole
MH0013 14cm 56cl (5.5" 20oz)
Box of 6
Round Acacia Wood Board
JMP803 16.2cm (6.5")
Box of 6



Round Calico Casserole
MH7005 14cm 56cl (5.5" 20oz)
Box of 6
Round Acacia Wood Board
JMP803 16.2cm (6.5")
Box of 6



Sizzle Platter with Wooden Base
MH7010 24cm (9.5")
Box of 1



Sizzle Platter with Wooden Base
MH7009 27cm (10.75")
Box of 1



Oval Eared Dish
MH7003 24cm 108cl (9.5" 38oz)
Box of 6
Oval Acacia Wood Board
JMP950 30.5 x 17.5cm (12 x 7")
Box of 6



Mini Wok with Lid
MH7001 21.5cm 58cl (8.5" 20oz)
Box of 6
Oval Acacia Wood Board
JMP946 22 x 16cm (8.5 x 6.25")
Box of 6





Eagle Enamel Plate
F50005 24cm (9.5")
 Box of 6



Eagle Enamel Pie Plate
F50009 22cm (9")
 Box of 6



Eagle Enamel Pie Plate
F50010 18cm (7.25")
 Box of 6



Eagle Enamel Bowl
F50012 13.5cm 54cl (5.25" 19oz)
 Box of 12



Eagle Enamel Pot
F50007 32cl (11.5oz)
 Box of 12



Eagle Enamel Pie Dish
F50003 20cm (7.75")
 Box of 6



Eagle Enamel Pie Dish
F50004 16cm (6.25")
 Box of 6



Eagle Enamel Baking Tray
F50018 28 x 21.5cm (11 x 8.5")
 Box of 6



Eagle Enamel Baking Tray
F51013
 35 x 12.5cm (13.75 x 5")
 Fits 3 x F51011 casserole dishes
 Box of 6

Cookware

Simmer stew serve

The Craft cookware range offers a variety of presentation opportunities to demonstrate the delights of oven to table cooking. This collection offers a range of items inspired by hand-crafted, simple country wares.



Oval Eared Dish
20 x 11cm 18.5cl (8 x 4 1/2" 6 1/2oz)
Box of 24
11300318 Blue



Oval Eared Dish
24.5 x 13.5cm 36cl (9 1/2 x 5 1/2" 12 1/2oz)
Box of 24
11330319 Terracotta



Oval Eared Dish
34 x 19cm 103cl (13 1/2 x 7 1/2" 36 1/2oz)
Box of 6
11310321 Green



Round Eared Dish
16.5cm 18.5cl (6 1/2" 6 1/2oz)
Box of 36
11330191 Terracotta



Round Eared Dish
19cm 54cl (7 1/2" 19oz)
Box of 12
11300316 Blue



Round Eared Dish
21.5cm 78cl (8 1/2" 27 1/2oz)
Box of 12
11310317 Green



Oval Baker
15.75cm 37cl (6 1/4" 13oz)
Box of 24
11300400 Blue



Roaster Square
25.5cm 185cl (10" 65oz)
Box of 6
11300329 Blue



Oblong Roaster
35.5 x 30.5cm 356cl (14 x 12" 125oz)
Box of 6
11310331 Green



Presentation Pan
25.5cm 96cl (10" 33 1/2oz)
Box of 6
11310866 Green



Casserole Base
16.5 x 12.4 x 5.7cm 42.5cl
(6 1/2 x 4 7/8 x 2 1/4" 15oz)
Box of 6
1131B828 Green
1155B828 White



Casserole Lid
12.4cm (4 7/8")
Fits B828
Box of 6
11310829 Green
11550829 White





* LIFETIME *
EDGE CHIP WARRANTY
YOUR CONFIDENCE ASSURED

Steelite Performance • Alumina Vitrified



Simplicity Cookware



Captivating casual dining

Bring the intoxicating aromas, sights and sounds of your menu to the guest as you captivate their senses with the Simplicity range of cookware.



Round Eared Dish
11010317
21.5cm 78cl (8 ½" 27 ½oz)
Box of 12
11010316
19cm 54cl (7 ½" 19oz)
Box of 12
11010191
16.5cm 18.5cl (6 ½" 6 ½oz)
Box of 36



Oval Sole Dish
11010326
28 x 19cm 148cl
(11 ⅞ x 7 ½" 52oz)
Box of 6
11010327
21.5 x 14cm 55cl
(8 ½ x 5 ½" 19oz)
Box of 12



Oval Baker
11010400
15.75cm 37cl (6 ¼" 13oz)
Box of 24



Oval Baker Lipped
11010328
15.75cm 37cl (6 ¼" 13oz)
Box of 24



Square Roaster
11010329
25.5cm 185cl (10" 65oz)
Box of 6



Oblong Roaster
11010331
35.5 x 30.5cm 356cl
(14 x 12" 125oz)
Box of 6
11010342
30.5 x 25.5cm 227cl
(12 x 10" 80oz)
Box of 6



Rectangular Tray
11010366
16.5 x 12.3cm 50cl
(6 ½ x 4 ¾" 17 ½oz)
Box of 12



Presentation Pan
11010866
25.5cm 96cl (10" 33 ½oz)
Box of 6



Casserole
11010337 3 Litre (5 ¼ pint)
Box of 2
Casserole 3 Litre Lid
11010338 Fits 0337
Box of 2
Casserole
11010334 2 Litre (3 ½ pint)
Box of 3
Casserole 2 Litre Lid
11010335 Fits 0334
Box of 3



Soup Bowl Covered Complete
11010828 42.5cl (15oz)
Box of 6
Soup Bowl Base Only
1101B828
16.5 x 12.4 x 5.7cm 42.5cl
(6 ½ x 4 ¾ x 2 ¼" 15oz)
Box of 6
Soup Bowl Lid
11010829
12.4cm (4 ⅞") Fits B828
Box of 12



Oval Eared Dish
11010321
34 x 19cm 103cl (13 ½ x 7 ½" 36 ½oz)
Box of 6
11010320
30.5 x 17cm 78cl (12 x 6 ½" 27 ½oz)
Box of 12
11010319
24.5 x 13.5cm 36cl (9 ½ x 5 ½" 12 ½oz)
Box of 24
11010318
20 x 11cm 18.5cl (8 x 4 ½" 6 ½oz)
Box of 24



This Stoneware range provides authentic, rustic serveware options. Gourmande is available in the classic colourways Midnight and Flame, and is ideal for use with wooden boards and stands, as well as being perfect for oven to table presentation.



Midnight Round Casserole
M14016
 14cm 79cl (5.5" 27.5oz)
 Box of 6



Midnight Round Casserole
M14018
 10cm 26cl (4" 9oz)
 Box of 6



Midnight Oval Casserole
M14020
 15cm 48cl (6" 17oz)
 Box of 6



Flame Round Casserole
M14019
 10cm 26cl (4" 9oz)
 Box of 6



Authentic and versatile

Estrella is an authentic collection of Spanish terracotta, crafted using traditional techniques that celebrate the heritage of tapas culture. Each piece is designed for true oven-to-table cooking, allowing dishes to be prepared, heated, and served in the same vessel for an immersive, genuinely Spanish dining experience.

Suitable for use in conventional ovens, microwaves, and freezers, the range marries rustic charm with everyday practicality. As with all artisanal terracotta, its natural character requires thoughtful handling to preserve its beauty and performance.



Rectangular Dish
M15014
19 x 14 x 4cm (7.5 x 5.5" 19.75oz)
Box of 22



Serving Dish
M15028 24cm 144cl (9" 50.75oz)
Box of 6
M15026 20cm (8")
Box of 7



Tapas Dish
M15001 15cm (6")
Box of 24



Tapas Dish
M15002 14cm (5.5")
Box of 10



Tapas Dish
M15019 13cm (5")
Box of 26



Tapas Dish
M15003 11.5cm (4.5")
Box of 24



Tapas Dish
M15004 10cm (4")
Box of 24



Tapas Dish
M15005 8cm (3.25")
Box of 24
M15033 6cm (2.5")
Box of 24



Casserole **NEW**
M15072
17cm 86cl (6.75" 30.25oz)
Box of 12



Casserole **NEW**
M15073
15cm 58cl (5.75" 20.5oz)
Box of 20



Lugged Casserole
M15013
17.5cm 86cl (7" 30.25oz)
Box of 12



Lugged Casserole
M15012
15cm 58cl (6" 20.5oz)
Box of 20



Lugged Casserole
M15011
13.5cm 37cl (5.25" 13oz)
Box of 20



Handled Fry Pan
M15009
17.5cm 64cl (7" 22.5oz)
Box of 18



Handled Fry Pan
M15008
13cm 25cl (5.25" 8.75oz)
Box of 22



Tapas Ramekin **NEW**
M15074
9.75cm 24cl (3.75" 8.5oz)
Box of 14



Tapas Ramekin
M15006
9cm 21cl (3.5" 7.25oz)
Box of 24



Tapas Ramekin
M15007
7.5cm 10cl (3" 3.5oz)
Box of 24



Tapas Pot **NEW**
M15075
7.75cm 18.5cl (3" 6.5oz)
Box of 16



Black Tapas Dish
M15057 17cm (6.75")
Box of 8



Black Tapas Dish
M15056 14cm (5.5")
Box of 10



Black Tapas Dish
M15055 11.5cm (4.5")
Box of 24



Avebury Blue is a stunning collection of decorated stoneware, designed to give the impression of classic rimmed enamel tableware.



Plate
CT6010 25.5cm (10")
Box of 6



Rectangular Dish
CT6007 22cm (8.5")
Box of 12



Rectangular Dish
CT6006 17.5cm (6.75")
Box of 12



Mini Casserole
CT6002
10.5cm 25cl (4" 8.75oz)
Box of 12



Milk Pan
CT6004
9.5cm 19cl (3.75" 6.75oz)
Box of 12



Ramekin
CT6018
9cm 20cl (3.5" 6.75oz)
Box of 12



Mug
CT6008 38cl (13.5oz)
Box of 12



The Titan Tapas collection is made from Porcelain rather than Terracotta producing a strong product that withstands the rigours of the Hospitality Industry, yet still creates an authentic look.



Round Tapas Bowl
M10010
13cm 29cl (5" 10.25oz)
Box of 6



Tapas Dish
M14013
13cm (5.25")
Box of 6



Tapas Dish
M14011
10cm (4")
Box of 6



Tapas Dish
M10028
9cm (3.5")
Box of 6



Tapas Deep Dish
M14008 7.5cm (3")
Box of 6



White Tapas Dish
M10032 13cm (5.25")
Box of 6



White Tapas Dish
M10030 10cm (4")
Box of 6



Rectangular Dish
K351619 20 x 14cm (8 x 5.5")
Box of 6
K351616 16 x 12cm (6.5 x 5")
Box of 6
K351613 13 x 9.5cm (5 x 4")
Box of 6



Ribbed Souffle/Pie Dish
M10003
11cm 40cl (4.5" 14oz)
Box of 6



Ribbed Ramekin
M10002 9cm 18cl (3.5" 6.25oz)
Box of 6
M10001 8cm 14cl (3" 5oz)
Box of 6
M10000 7cm 6cl (2.5" 2oz)
Box of 6



Ramekin
M00009
9.5cm 18cl (3.75" 6.75oz)
Box of 12
M00008
8cm 11cl (3" 3.75oz)
Box of 12



Ramekin
K70002 7cm (2.75")
Box of 12
M00006
6.5cm 7cl (2.5" 2.5oz)
Box of 12



Round Eared Dish
M00021 21cm (8.25")
Box of 6
M00018 18cm (7")
Box of 6
M00015 15cm (5.5")
Box of 6
M00013 13cm (5")
Box of 12



Oval Eared Dish
M00132 32cm (12.5")
Box of 4
M00128 28cm (11")
Box of 4
M00125 25.5cm (10")
Box of 4



Oval Eared Dish
M00122 22cm (8.5")
Box of 4
M00116 16.5cm (6.5")
Box of 12



Oval Pie Dish
M00316
16cm 38cl (6.25" 13.5oz)
Box of 6



Oval Lipped Pie Dish
M00320
18cm 38cl (7" 13.25oz)
Box of 6



Round Cane Dish
M10014
18cm 67cl (7" 23.5oz)
Box of 6
M10013
16cm 46cl (6.75" 16.25oz)
Box of 6



Oval Cane Dish
M10016
17 x 11cm 36cl
(6.5 x 4.25" 12.75oz)
Box of 6



Oval Cane Dish
M10015
14 x 10cm 20cl (5.5 x 4" 7oz)
Box of 6



Large Oval Platter
K90094 53 x 21cm (21 x 8.75")
Box of 6



Gastronorm
M10025 1/1 GN 53 x 32.5 x 5.5cm
Box of 1
M10024 1/2 GN 32.5 x 26.5 x 10cm
Box of 1
M10023 1/2 GN 32.5 x 27.5 x 6cm
Box of 1

Gastronorm
M10021 1/3 GN 32 x 18 x 10cm
Box of 1
M10022 1/3 GN 32 x 18 x 5cm
Box of 1



Induction, Chafing Fuel & Burners

Commercial catering is easier with induction, chafing fuel and burner solutions from Steelite-Utopia. The best alternative to open flame, induction technology utilises magnetic currents to heat pots, pans & chafing dishes to provide a safe & efficient cooking experience. Chafing fuel from Hollowick is portable, easy to use, and provides consistent heat for hours, making them the ideal choice for catering events.

The combination of these options gives any foodservice operator the flexibility to host a variety of events, ensuring that food is cooked & served at the right temperature for maximum enjoyment.



Power Cell

Cordless warming induction for use anywhere

The D.W. Haber Power Cell is a revolutionary solution for keeping food hot for extended periods of time. The sleek and elegant design makes it a stylish addition to buffets & food stations, and its cordless battery operation allows it to be used anywhere. The Power Cell has a 5.5 hour recharge time so it can be used for multiple meals per day, and it is a cost-saving solution as it compares to repetitive purchases of chafing fuel. The first of its kind, this induction unit is energy-efficient and operates quietly, ensuring that it won't disturb the ambiance of the setting.



Accessories



Power Cell Cordless Induction Range Patent-Pending
220V EU & UK Plug
DWELINPCE2E3
37.1 x 33 x 7.6cm (14 5/8 x 13 x 3")
Box of 1



Power Cell Travel Case
DWELINPCCASE
48.3 x 40.3 x 18.1cm (19 x 15 7/8 x 7 1/8")
Box of 1



Hollowick • Liquid Chafing Fuel

Easy Heat



Maximum heat performance

The proper placement of any chafing fuel source is critically important to have maximum heat performance. With Hollowick Easy Heat® Chafing Fuels, the wick is adjustable to accommodate different temperature levels and the can stays cool for easy handling. Simply adjust the wick to change the heat output between standard, low and high, then place on the fuel holder or table beneath to properly heat the chafing dish.

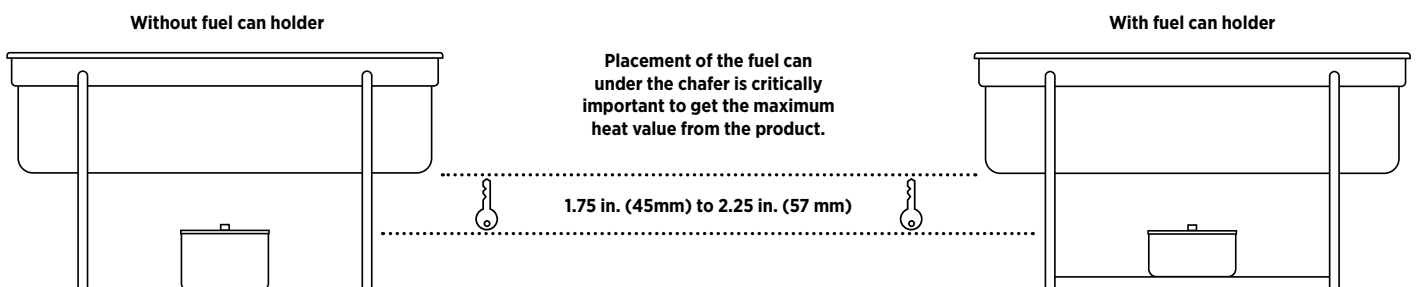



Consistent flame & adjustable heat

Easy Heat® liquid chafing fuels are the go-to choice for buffet service. With a consistent flame for even heat, the wicks are located outside the canister keeping the flame position the same as it burns and the can cool so servers can easily handle during service. The wicks are also easily adjustable to provide different levels of heat to suit operator needs. Comprised of Diethylene Glycol, Hollowick's Easy Heat® fuels are non-flammable and enclosed in a sealed canister to prevent spill accidents and reuse on separate occasions.



3 Heat Settings
Standard 6 hr
High 3 hr
Low 8 hr

Easy Heat
HWZ638
Box of 24
Burn Time: 6-3- or 8 hours



3 Heat Settings
Standard 4 hr
High 2 hr
Low 5 hr

Easy Heat
HWZ425
Box of 24
Burn Time: 4-2- or 5 hours



3 Heat Settings
Standard 2 hr
High 1 hr
Low 3 hr

Easy Heat
HWZ213
Box of 48
Burn Time: 2-1- or 3 hours



Heat Lamps

Ideal for maintaining safe temperatures while chefs prepare and serve food on a buffet, this collection of heat lamps will create a standout presentation. With telescoping lamps your catering expectations will be far exceeded through features such as multiple finishes.



Versatile buffet presentation

Expanding your hot buffet just got easier with heat lamps from Creations. These fixed-height lamps are available with a standard power cord for both UK and EU usage. Available in both single and double heads, the Creations heat lamps offer brilliant functionality and make a statement with any buffet presentation. Now available with a black powder coating for versatile buffet style and durability.



Modern Black Single Heat Lamp 55.9cm (22") H
7351MWB310E2 EU Plug 220V
Box of 1
7351MWB310E3 UK Plug 220V
Box of 1



Modern Black Double Heat Lamp 55.9cm (22") H
7351MWB311E2 EU Plug 220V
Box of 1
7351MWB311E3 UK Plug 220V
Box of 1



Portable Stainless Steel Modern Heat Lamp Single Head 55.9cm (22") H
7351MW310E2 EU Plug 220V
Box of 1
7351MW310E3 UK Plug 220V
Box of 1



Portable Stainless Steel Modern Heat Lamp Double Head 55.9cm (22") H
7351MW311E2 EU Plug 220V
Box of 1
7351MW311E3 UK Plug 220V
Box of 1

All Single Head Lamps: 110v | 250 watt | 2.3 Amp • All Double Head Lamps: 110v | 500 watt | 4.5 Amp • Heat Lamp Bulb: Philips BR125 IR 250w E27 230-250V
All lamps are 16" from table to lamp shade. For 220v Schuko plug add 'E2' to product code, for 220v UK plug add 'E3'.



Beverage Service & Cereal Dispensers

Beverage service & cereal dispensers are essential for venues looking to create the ultimate buffet presentation. Steelite-Utopia's Collection of 18/10 stainless steel beverage servers provide elegance & style, while the durability is tested and approved for commercial foodservice.

Cereal dispensers help minimise waste and maintain cleanliness, creating that lasting impression that professional caterers desire.



Axis Beverage Collection **NEW**

Sleek beverage solutions

Elegant and efficient, Creations Coffee Urns and Juice Dispensers are designed to elevate any buffet setup. The tall and sleek fuel urns feature a concealed fuel can in the base post, ensuring a modest heat source for beverages. Perfectly balancing form and function, these urns and dispensers provide a sophisticated look that complements a range of settings, from brunch spreads to high-end hotel buffets.



Black Juice Dispenser
7356MW319
20.3 x 26.7 x 60.3cm 11.4L
(8 x 10 1/2 x 23 3/4" 3gal)
Handwash Only
Box of 1



Black Juice Dispenser
7356MW318
20.3 x 26.7 x 45.7cm 3.8L
(8 x 10 1/2 x 18" 1gal)
Handwash Only
Box of 1

Punch Barrels



Introducing the perfect party companion

The Nantucket & Bon Bon Punch Barrels provide an authentic rustic feel to your foodservice presentation. Available in a few sizes, these dispensers are perfect for outdoor parties, hotel lobbies, buffets and more. With features like clip top lids, acacia stands, and easy-to-use taps, these barrels are perfect for serving freshly squeezed lemonade, infused waters or pre-batched cocktails.



Ribbed Punch Barrel
R90520
 6L (211oz) H 305mm
 Fits Stand R90135, JMP829
 Box of 1



Country Style Punch Barrel
R90021
 6L
 H 360mm
 Fits Stand R90135, JMP829
 Box of 1



Country Style Punch Barrel
R90022
 4L
 H 260mm
 Fits Stand JMP831
 Box of 1



Nantucket Punch Barrel
R90030
 8.5L
 H 365mm
 Fits Stand R90135, JMP829
 Box of 1



Nantucket Punch Barrel
R90033
 4.5L
 H 320mm
 Fits Stand JMP831
 Box of 1



Bon Bon Punch Barrel
R90034
 8L
 H 390mm
 Fits Stand R90135, JMP829
 Box of 1

Spare Punch Barrel Taps
R90039 Box of 1



Stand
R90135
 Fits R90021, R90520,
 R90030 & R90034
 Box of 1



Acacia Punch Barrel
 Stand/Bowl
JMP829
 21.5cm (8.5")
 Fits R90021, R90520,
 R90030 & R90034
 Box of 1



Acacia Punch Barrel
 Stand/Bowl
JMP831
 17cm (6.75")
 Fits R90022, R90033
 Box of 1



Beverage service done right

Serve chilled beverages the right way with D.W. Haber's collection of juice dispensers. Available in Tempo, Tower, Millennium, and Fusion, the juicers have an ice sleeve in the centre to keep drinks chilled, and a universal base fits three different sized juice vessels.



Tempo



Tempo Juicer
DW12JLWSS
 30.5cm 11.4L (12 x 10 x 25 1/2" 12qt)
 Box of 1
DW07JLWSS
 27.9 x 27.9 x 50.8cm 6.6L (11 x 11 x 20" 7qt)
 Box of 1
 Hand Wash Only

Ash Grey Teak



Juicer w/ Wood Base
DW12JLWDAG 11.4L (12qt)
 Universal stand fits 3 size containers
 Box of 1
DW07JLWDAG 6.6L (7qt)
 Universal stand fits 3 size containers
 Box of 1
DW04JLWDAG 3.8L (4qt)
 Universal stand fits 3 size containers
 Box of 1

Hand Wash Only

Grey Wash Teak



Juicer w/ Wood Base
DW12JLWDGW 11.4L (12qt)
 Universal stand fits 3 size containers
 Box of 1
DW07JLWDGW 6.6L (7qt)
 Universal stand fits 3 size containers
 Box of 1
DW04JLWDGW 3.8L (4qt)
 Universal stand fits 3 size containers
 Box of 1

Hand Wash Only

Natural Teak



Juicer w/ Wood Base
DW12JLWDT 11.4L (12qt)
 Universal stand fits 3 size containers
 Box of 1
DW07JLWDT 6.6L (7qt)
 Universal stand fits 3 size containers
 Box of 1
DW04JLWDT 3.8L (4qt)
 Universal stand fits 3 size containers
 Box of 1

Hand Wash Only



Drip Tray w/ Drainer
DW30045SET
 13.4cm (5 1/4")
 Box of 2



Axis Buffet Collection

Effortless breakfast service

Creations cereal and milk dispensers bring convenience and style to any breakfast bar. The triple cereal dispenser features a rotating base, making it easy for guests to serve themselves from all angles. Built with durable acrylic bodies, these dispensers ensure clear visibility of contents, allowing guests to quickly choose their favourite cereals. Designed for effortless service, add a refined touch to any breakfast buffet.



Black Insulated Milk Urn and Base
7354MW311
30.5 x 17.8 x 53.3cm 2.8L
(12 x 7 x 21" 3qt)
Box of 1



Black Double Cereal Dispenser
7356MW320
43.5 x 28.6 x 69.5cm 3.5L
(17 1/8 x 11 1/4 x 27 3/8" 3 3/4qt)
Handwash Only
Box of 1



Beautiful display, mess-free service

Ideal for hotels, restaurants, and cafeterias, the Creations Cereal Dispensers feature an elongated tube to beautifully display and serve your favourite cereals. The rubber turn-style mechanism warrants a mess-free service, ensuring that the food won't crumble and helps control food cost. Find the perfect match for the cereal dispensers in the D.W. Haber Insulated Milk Dispensers. Available in Tempo, Tower or Millennium, these dispensers are designed with an ice sleeve that keeps milk at refrigerator temperature for over 5 hours.



Single Cereal Dispenser
7345MW116
31.8 x 24.8 x 78.7cm 11L
(12 1/2 x 9 3/4 x 31" 11.6qt)
Box of 1

D.W. Haber
Milk & Dispenser 



Tempo Insulated Milk Dispenser w/ Ice Sleeve SS
DW055MLWSS
27.9 x 27.9 x 50.8cm 5.2L
(11 x 11 x 20" 5 1/2qt)
Keeps milk at refrigerator temperature for over 5 hours.
Box of 1

Fusion Buffet Wood Base
DW055MLWDT Natural Teak
DW055MLWDAG Ash Grey
DW055MLWDGW Grey Wash

Hepp



HEPP

Beverage, Milk & Cereal Dispensers



These dispensers from Hepp are designed with modern lightness to dispense cool milk and juices hygienically and without dripping. A wide variety of cereals are dispensed in exact portions. Hepp's heated, coffee urns with beautiful sheen are also a striking centrepiece for any buffet.



Excellent Coffee Urn
51471074
 5L (176oz)
 Box of 1
 Excellent Coffee Urn
51471508
 10L
 Box of 1
 Excellent Coffee Urn
51471057
 15L (528oz)
 Box of 1



Excellent Juice Dispenser
51471843
 6.5L (227 ½oz) Per Cylinder
 Box of 1



Excellent Milk Dispenser
51471619
 6.5L (227 ½oz) Per Cylinder
 Box of 1



Excellent In-Line Cereal Dispenser
51471842
 3.5L (123oz) Per Cylinder
 Box of 1

Hepp



HEPP

Beverage Service & Chillers



Hepp's traditional manufacturing excellence come together to create an exceptional range of tabletop, buffet, accent pieces and accessories. Manufactured in 18/10 stainless steel or silver, all items have superb durability and inherent strength with a high resistance to staining to ensure a perfect presentation.



Excellent Champagne Bowl /
w/ Ring SS
51471677
38.5cm (15 1/8")
Box of 1



Excellent 1 Bottle Wine
Cooler SS
51471861
16.8cm (6 3/8")
Box of 1



Excellent 2 Bottle Wine
Cooler SS
51471415
23.1cm (9")
Box of 1



Excellent Double Walled Ice
Bucket SS
51471438
4.8cm (5 5/8")
Box of 1



Excellent 1 Bottle Wine
Cooler Stand SS
51471872
6.2cm (6 3/8")
Box of 1
Excellent 2 Bottles Wine
Cooler Stand SS
51471873
18cm (7")
Box of 1



Vision Insulated 2 Bottle
Champagne Cooler
50721574
21.6cm (8 1/2") Dia
Box of 1



Neutral Toothpick Stand SS
50161942
8cm (3 1/8")
Box of 1



Neutral Round Service Tray
50161262
36.9cm (14 1/2")
Box of 1



Neutral Serving Tray
50161263
30.5 x 25.4cm (12 x 10")
Box of 1

Non-stock. Available on request and subject to an estimated 4 week lead time.



Wine Stand For 2 Bottle Oval Scoop
Cooler SS
DW040062VSS
40.6 x 20.3cm (16 x 8")
Box of 1
Oval Scoop Wine Cooler 2 Bottle
DW040162VSS
26.7 x 20.3cm (10 1/2 x 8")
Box of 1



Wine Stand Base For Single And Double
Wine Buckets Stainless Steel
DW040042BASESS Box of 1
Wine Stand Nest For Double Wine
Bucket Stainless Steel
DW040042NESTSS Box of 1
Wine Stand Post For Single And Double
Wine Buckets Stainless Steel
DW040042POSTSS Box of 1
Wine Stand For Double Wine Cooler
DW040042SS
30.5cm (12 x 9 x 24")
Box of 1
Double Wine Cooler w/ Ogee Border
DW040142SS
26.7 x 24.1cm (10 1/2 x 9 1/2")
Box of 1



Keep things cool with our range of wine buckets and coolers.



Wine/Champagne Bag Clear
HD0869
 25cm (10")
 Box of 6



Double-Walled Wine Cooler
F91105
 11.5 x 20cm (4.5 x 8")
 Box of 6



Double Walled Wine Cooler -
 Copper
F91122
 11.5 x 20cm (4.5 x 8")
 Box of 6



Champagne Bowl
F91117
 38 x 22.7cm H (15")
 Box of 1



Stainless Steel 18/10
 Champagne Bucket
F91008
 21.5 x 21.5cm H (8.5")
 Fits stand F91009
 Box of 1



Aluminium Wine Bucket
F91107
 20 x 22cm H (7.5 x 8.5" H)
 Box of 6



Ribbed Wine Bucket
F91110
 20 x 19cm H (8 x 7.5" H)
 Box of 6



Tulip Ring Handled Wine
 Bucket
F91108
 22 x 22cm H (8.5 x 8.5" H)
 Box of 6



Wine Bucket
F91106
 20 x 20cm H (8 x 8" H)
 Box of 6



Table Edge Wine Bucket Stand
F91111
48cm (19")
Box of 6



Stainless Steel 18/10 Champagne Stand
F91009
62cm (24")
Holds F91107, F91108, F91110 and F91008
Box of 1



Champagne Bucket Stand
F91113
69cm (27")
Holds F91107, F91108 and F91110
Box of 1

Buckets



Small Champagne Bucket
Clear
HD0865
27 x 19.6cm H (10.5")
Box of 6



Small Champagne Bucket
Black
HD0867
27 x 19.6cm H (10.5")
Box of 6



Large Champagne Bucket
Black
HD0868
35 x 25.5cm H (13.75")
Box of 2



Copper Banded Champagne Bucket
HD0889
30.5 x 23.5cm H (12")
Box of 2



Strahl
Da Vinci **STRAHL**
INCREDIBLE STRENGTH



PC

Ice Bucket
N562603 2.3L (81oz)
H 22.9cm (9") M 22.9cm (9")
T 16.8cm (6 5/8") B 13.7cm (5 3/8")
Box of 3



A new darker take on our Stainless Steel barware, the satin finish adds an air of drama to the hammered texture and contrasts with the bright interior. Ideal for bars, restaurants and events this collection sits perfectly in any location. The double walled Cooler keeps wine chilled for the perfect serve.



Matt Black Wine Cooler
F91223
 12 x 20cm (4.75 x 8")
 Box of 6



Gunmetal Wine Cooler
F91220
 12 x 20cm (4.75 x 8")
 Box of 6



Gunmetal Wine Bucket
F91222
 19.5 x 21cm (7.75 x 8.25")
 Box of 6



Gunmetal Handled Ice Bath
F91221
 40 x 30cm (15.75 x 11.75")
 Box of 2



Aged Copper Double-Walled Wine Cooler
F91217
 12 x 20cm (4.75 x 8")
 Box of 6



Aged Copper Wine Bucket
F91219
 19.5 x 21cm (7.5 x 8.25")
 Box of 6



Aged Copper Handled Ice Bath
F91218
 40 x 30cm (15.75 x 8")
 Box of 2



Satin

The faceted surface and satin finish lend this double walled collection an air of contemporary refinement.



Satin Double-Walled Wine Cooler
F91211
12 x 20cm (4.75 x 8")
Box of 6



Satin Double Walled Wine Bucket
F91210
20 x 21.5cm (8 x 8.5")
Box of 6



Satin Double Walled Handled Ice Bath
F91212
37 x 19cm (14.5 x 7.5")
Box of 1



Satin Double-Walled Punch Bowl/Wine Cooler
F91213
37 x 26cm (14.5 x 10")
Box of 1



Custom Powder Coating

Create a unique buffet presentation with custom powder coat options on our stainless steel buffetware. Available in a textured finish and a wide variety of colours, high temperature powder coat is durable, dishwasher safe, hides fingerprints and creates a new fresh look on any buffet.



Custom powder coating

Powder Coating is a popular option for buffet products in the commercial foodservice industry. It's a type of coating that is applied as a free-flowing, dry powder to the surface of a product. Powder coating creates a hard, durable finish that is resistant to scratches, chipping and fading, making it ideal for high volume use and a demanding buffet service environment. It also enables operators to tailor the colour & finish of chafing dishes, urns, or heat lamps to match their brand or decór. Available in a vast selection of colours or finishes, create a professional and cohesive look on any buffet service with custom powder coating. Contact us today to learn more!

Endless Colour Options



Black



Copper



White

Two Tone Options Available



Add a Textured Finish



Hammered
Copper



Textured
White

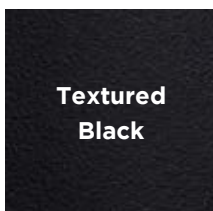

Textured
Black



Tempo Vacuum Insulated Urn Textured White

DW45WTVACWTSS ●
43.2cm 19L (17 x 16 x 31" 5gal)
Box of 1

DW43WTVACWTSS ●
38.1cm 11.4L (15 x 14 ½ x 27" 3gal)
Box of 1

DW41WTVACWTSS ●
35.6cm 5.7L (14 x 24" 1 ½gal)
Box of 1



Tempo Sterno Urn Textured Black

DW45WBKSS ●
38.1cm 19L (15 x 14 ½ x 27" 5gal)
Box of 1

DW43WBKSS ●
35.6cm 11.4L (14 x 14 x 23" 3gal)
Box of 1

DW41WBKSS ●
33cm 5.7L (13 x 12 x 19" 1 ½gal)
Box of 1

For further details and a full offering of available options contact your customer service rep.

● Non-Stock



Platters, Bowls & Risers

With a range of options available including square & rectangle plates, large bowls, sharing platters and gastronorm trays, Steelite-Utopia offers a number of serving vessels which are perfectly suited for patio dining, banquets and buffet dining. Each collection offers a unique style that can inspire and elevate your plating, helping you to create show stopping food presentations.

Anton Black® Whiteware

The Anton Black collection exudes elegance and contemporary design, together with exceptional strength. This whiteware collection of complementary designs and shapes can be combined to create the perfect table setting for every occasion.

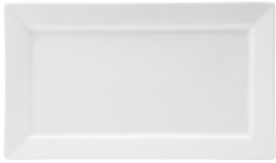

Matrix Rectangular Plate
Z03032 36 x 21cm (14 x 8.25")
Box of 6



Matrix Rectangular Plate
Z03030 30 x 18cm (12 x 7")
Box of 6

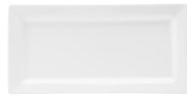

Matrix Rectangular Plate
Z03029 24 x 12cm (9.5 x 4.5")
Box of 6



Presentation Board
Z03042 33 x 23cm (12.75 x 9")
Box of 6



Mini Elipse Bowl
Z06017 8cm 6cl (3" 2oz)
Box of 6



Elements Butter Tray
Z03088 10cm (4")
Box of 6



Handled Tasting Dish
Z06015 7cm 5cl (2.5" 1.75oz)
Box of 6



Ramekin
Z05006 9cm (3.5")
Box of 6



Elements Pot
Z03194 6.5cm (2.25")
Box of 6



Deep Square Dish
Z03097 6.5cm 9cl (2.5" 3oz)
Box of 6



Shallow Square Dish
Z03096 6.5cm 3cl (2.5" 1oz)
Box of 6



Elements Gravy Boat
Z03304 30cl (11oz)
Box of 6



Elements Salt Pourer
Z03302S 9.5cm (3.75")
Box of 6
Elements Pepper Pourer
Z03302P 9.5cm (3.75")
Box of 6



The Titan collection has been created to offer practical and durable solutions without compromising superb presentation. A comprehensive range of Hotelware has been designed to cover all of the market's requirements from dining through to service and oven to tableware.



Large Oval Platter
K90094 53 x 21cm (21 x 8.75")
 Box of 6



Rectangular Plate
K50078 36 x 23cm (14 x 9")
 Box of 12



Rectangular Plate
K50079 30 x 20cm (12" x 8")
 Box of 12



Platter
K92000
 34 x 23cm (13.5 x 9")
 Box of 6



Platter
K92005
 29 x 19.5cm (11.5 x 7.5")
 Box of 6



Platter
K92004
 24 x 16.5cm (9.5 x 5.5")
 Box of 6



Options Rectangular Plate
A2004 30 x 18cm (12" x 7")
 2 Boxes of 6



Signature Rectangular Platter
K90002
 24 x 12cm (9.5 x 4.75")
 Box of 6



Pizza Plate
K162932 32cm (12.5")
 Box of 6
K162928 28cm (11")
 Box of 6



Gourmet Square Tray
K90070 15cm (6")
 Box of 6



Square Dish
A4087 6.6cm (2.5")
 6 Boxes of 12



Gourmet 4 Round Bowls & Tray
K90050
 24.5 x 7cm 6cl (9 x 2.75" 2oz)
 6 Sets



Pompeii

Lightweight, high durability

Creations Pompeii Buffet generates an astonishing and memorable display. Designed for both hot and cold, this melamine collection provides high-quality design with versatility among foodservice presentations. Available in slate and stone colours, Pompeii Buffet is dishwasher safe and its break resistant structure eliminates the need to sacrifice visual quality for durability.



Large Round Bowl
41.3 x 17.5cm 15.3L (16 ¼ x 6 ⅞" 16 ¼qt)
Box of 2
7184TM045A Slate
7194TM045A Stone



Large Round Bowl
35.6 x 14.9cm 9.1L (14 x 5 ⅝" 9 ⅝qt)
Box of 2
7184TM044A Slate
7194TM044A Stone



Medium Round Bowl
28.6 x 11.7cm 4.5L (11 ¼ x 4 ⅜" 4 ¼qt)
Box of 4
7184TM042A Slate
7194TM042A Stone



Small Round Bowl
24.4 x 9.5cm 2.25L (9 ⅝ x 3 ¾" 2 ⅝qt)
Box of 6
7184TM040A Slate
7194TM040A Stone



Large Shallow Round Bowl
35.9 x 6.7cm 4.5L (14 ½ x 2 ⅝" 4 ¾qt)
Box of 4
7184TM043A Slate
7194TM043A Stone



Medium Shallow Round Bowl
29.8 x 6.7cm 2.5L (11 ¼ x 2 ⅝" 2 ⅝qt)
Box of 6
7184TM041A Slate
7194TM041A Stone



Gastronorm Platter ⅓
53 x 32.7cm (21 x 12 ¾")
Box of 1
7184TM049A Slate
7194TM049A Stone



Gastronorm Platter ⅓
53 x 16.5cm (21 x 6 ⅝")
Box of 1
7184TM048A Slate
7194TM048A Stone



Gastronorm Platter ½
32.4 x 27cm (12 ¾ x 10 ½")
Box of 3
7184TM047A Slate
7194TM047A Stone



Gastronorm Platter ⅓
32.4 x 17.5cm (12 ¾ x 7")
Box of 3
7184TM046A Slate
7194TM046A Stone



Stylish, versatile buffet presentation

Add that something extra to your buffet presentation with Gastronorm Trays by Creations. Available in a variety of sizes with corresponding covers, these large display platters come in a number finishes to suite any occasion. Offering style and versatility, Gastronorm Trays are great for an array of foods while providing a stunning presentation every time.

Covers



GN ¼ Cover
6470ML10
53.6 x 33.1 x 9.15cm (21 x 13 x 3 ½")
Box of 1



GN ½ Cover
6470ML11
33.1 x 27.1 x 9.15cm (13 x 10 ½ x 3 ½")
Box of 3



GN ⅓ Cover
6470ML12
33.1 x 18.2 x 9.15cm (13 x 7 ¼ x 3 ½")
Box of 3



GN ¾ Cover
6470ML13
53.6 x 16.8 x 9.15cm (21 x 6 ⅝ x 3 ½")
Box of 1

Quarry

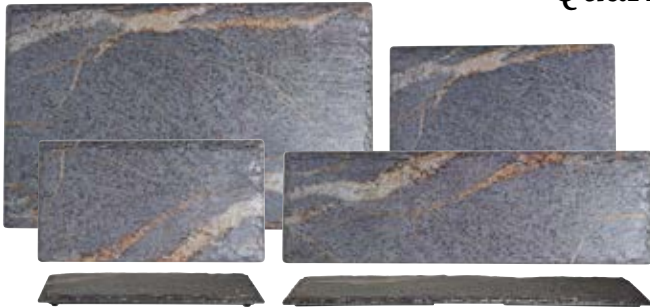

GN ¼ Rectangle Tray
7192TM307 53 x 32.5cm
Box of 2
GN ½ Rectangle Tray
7192TM308 32.5 x 17.6cm
Box of 2

GN ½ Rectangle Tray
7192TM309 32.5 x 26.5cm
Box of 2
GN ¾ Rectangle Tray
7192TM310 53 x 16.2cm
Box of 2

Craft



GN ¼ Rectangle Tray
68A416EL591
53 x 32.5cm (21 x 12 ¾")
Box of 1
GN ½ Rectangle Tray
68A416EL595
32.5 x 17.6cm (12 ¾ x 7")
Box of 3

GN ½ Rectangle Tray
68A416EL593
32.5 x 26.5cm (12 ¾ x 10 ½")
Box of 3
GN ¾ Rectangle Tray
68A416EL597
53 x 16.2cm (21 x 6 ⅝")
Box of 1

Pompeii



Gastronorm Platter ¼
53 x 32.7cm (21 x 12 ¾")
Box of 1
7184TM049A Slate
7194TM049A Stone
Gastronorm Platter ½
32.4 x 17.5cm (12 ¾ x 7")
Box of 3
7184TM046A Slate
7194TM046A Stone

Gastronorm Platter ½
32.4 x 27cm (12 ¾ x 10 ½")
Box of 3
7184TM047A Slate
7194TM047A Stone
Gastronorm Platter ¾
53 x 16.5cm (21 x 6 ⅝")
Box of 1
7184TM048A Slate
7194TM048A Stone

Slate



GN ¼ Rectangle Tray
68A415EL591
53 x 32.5cm (21 x 12 ¾")
Box of 1
GN ½ Rectangle Tray
68A415EL595
32.5 x 17.6cm (12 ¾ x 7")
Box of 3

GN ½ Rectangle Tray
68A415EL593
32.5 x 26.5cm (12 ¾ x 10 ½")
Box of 3
GN ¾ Rectangle Tray
68A415EL597
53 x 16.2cm (21 x 6 ⅝")
Box of 1



GN ¼ Rectangle Tray
68A351EL590
53 x 32.5cm (21 x 12 ¾")
Box of 1
GN ½ Rectangle Tray
68A351EL594
32.5 x 17.6cm (12 ¾ x 7")
Box of 3

GN ½ Rectangle Tray
68A351EL592
32.5 x 26.5cm (12 ¾ x 10 ½")
Box of 3
GN ¾ Rectangle Tray
68A351EL596
53 x 16.2cm (21 x 6 ⅝")
Box of 1

Driftwood



Craft

Craft melamine extends to buffet service

Give your buffet an upgrade with these large melamine serving pieces from Creations. Designed to replicate our ever-popular Craft dinnerware collection, this melamine offering is made to withstand the rigours of foodservice and is dishwasher safe. Craft melamine has a neutral colour palette that blends well with existing service items, providing the opportunity for a customer to create a personalised and on-trend presentation.



Extra Large Round Bowl
68A632EL863
38.1 x 15.2cm H 11.8L (15 x 6" H 12 ½qt)
Box of 2



Large Round Bowl
68A632EL862
33 x 12.7cm H 7.6L (13 x 5" H 8qt)
Box of 3



Medium Round Bowl
68A632EL861
27.9 x 10.2cm H 3.8L (11 x 4" H 4qt)
Box of 3



Small Round Bowl
68A632EL864
22.9 x 7.6cm H 2.1L (9 x 3" H 2 ¼qt)
Box of 12



Square Pebble Bowl
68A632EL865
34.3 x 7.6cm H 2.8L (13 ½ x 3" H 3qt)
Box of 6



Square Pebble Bowl
68A632EL867
25.4 x 3.8cm H 0.9L (10 x 1 ½" H 1qt)
Box of 6



Medium Round Platter
68A632EL860
33 x 5.1cm H 3.3L (13 x 2" H 3 ½qt)
Box of 12



GN ¼ Rectangle Tray
68A416EL591
53 x 32.5cm (21 x 12 ¾")
Box of 1



GN ½ Rectangle Tray
68A416EL593
32.5 x 26.5cm (12 ¾ x 10 ½")
Box of 3



GN ¾ Rectangle Tray
68A416EL597
53 x 16.2cm (21 x 6 ⅜")
Box of 1



GN ½ Rectangle Tray
68A416EL595
32.5 x 17.6cm (12 ¾ x 7")
Box of 3





Quarry

Long-lasting & robust

Reminiscent of a deep blue sky and rocky mountain hillside is the Quarry collection by Creations Melamine. These hearty platters and bowls feature a unique, stone-like decal on a highly durable melamine body and are ideally sized to meet the needs of any buffet presentation.



Bowl
7192TM302A
37.5 x 32.1 x 9.2cm 520.5cl
(14 ¾ x 12 ⅝ x 3 ⅝" 5 ½qt)
Box of 1



Bowl
7192TM301A
43.2 x 24.1 x 7.6cm 260.2cl
(17 x 9 ½ x 3" 2 ¾qt)
Box of 1



Square Bowl
7192TM300A
26.03 x 24.8 x 7.6cm 189cl
(10 ¼ x 9 ¾ x 3" 2qt)
Box of 1



V Shape Bowl
7192TM303A
25.1 x 25.1 x 15.6cm 402.2cl
(9 ⅞ x 9 ⅞ x 6 ⅛" 4 ¼qt)
Box of 1



Platter
7192TM304A
45.7 x 22.9 x 3.8cm (18 x 9 x 1 ½")
Box of 1

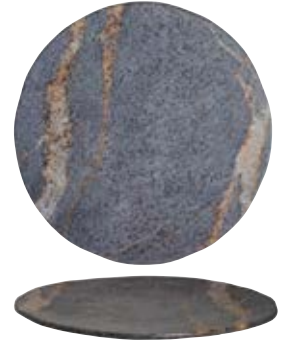

Round Platter
7192TM305 34.9cm (13 ¾")
Box of 3



GN ⅓ Rectangle Tray
7192TM307
53 x 32.5cm
Box of 2

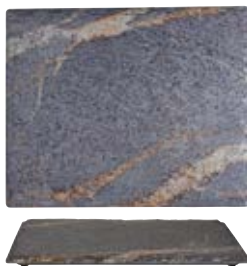

GN ⅓ Rectangle Tray
7192TM309
32.5 x 26.5cm
Box of 2



GN ⅓ Rectangle Tray
7192TM308
32.5 x 17.6cm
Box of 2

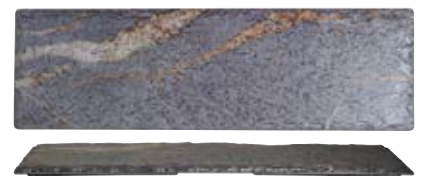

GN ¼ Rectangle Tray
7192TM310
53 x 16.2cm
Box of 2



Scape

Natural, subtle textures

Inspired by the living elements of a natural landscape, Scape portrays subtle textures and colours that are organically created in nature. Scape offers a free-flowing design with a multi-material approach to transition from casual to formal dining styles and enhances buffet presentations. Available in high alumina vitrified china, melamine, and glass, Scape offers exceptional style, durability, and grace while delivering a genuinely innovative experience.



Plate
68A451EL707 Dia 28cm (11")
Box of 6



Plate
68A451EL706 Dia 23cm (9")
Box of 6



Plate
68A451EL705 Dia 16.5cm (6 ½")
Box of 6



Large Oval Platter
68A451EL703
40 x 24.2cm (16 x 9 ½")
Box of 1



Medium Deep Bowl
68A451EL704
18 x 7.8cm H 40cl (7 x 3" 13 ½oz)
Box of 6



Small Deep Bowl
68A451EL708
13 x 5.3cm H 15cl (5 x 2" 5oz)
Box of 6



Calypso

Big, bold and endlessly practical, Calypso melamine bowls and platters bring warmth and texture to any serve. Ideal for outdoor entertaining and buffet service.



Calypso Blue Bowl
CT1042 34cm (13.5")
4 Boxes of 6



Calypso Blue Plate
CT1043 35cm (14")
4 Boxes of 6



Calypso Red Bowl
CT1044 34cm (13.5")
4 Boxes of 6



Calypso White Bowl
CT1046 34cm (13.5")
4 Boxes of 6



Calypso White Plate
CT1047 35cm (14")
4 Boxes of 6

Wildwood

The Wildwood range combines the unique appearance of hand thrown ceramics with the lightness and durability of melamine - practical and long lasting, without compromising on style.



Wildwood Blue Platter
CT1036 52.5 x 30cm (20.75 x 11.75")
 Box of 6



Wildwood Large Blue Bowl
CT1038 35cm (13.75")
 Box of 6



Wildwood Blue Bowl
CT1037 25.5cm (10")
 Box of 6



Wildwood Green Platter
CT1039 52.5 x 30cm (20.75 x 11.75")
 Box of 6



Wildwood Green Bowl
CT1040 25.5cm (10")
 Box of 6

Wood Effect Platters

Timber Melamine platters have a rustic wood effect on one side with a white glossy finish on the other. Elm platters have moulded in feet to enable easy manoeuvring.



Elm Footed Round Platter
JMP035 35cm (13.5")
 Box of 2

Pebble Platters

Pebble melamine platters combine the appearance of real stone with the durability of melamine, being practical, long-lasting and chip resistant.



Pebble Platter White
CT9089 41 x 30cm (16 x 11.75")
 Box of 6



Pebble Platter Grey
CT9090 41 x 30cm (16 x 11.75")
 Box of 6

Reversible Platters

Utopia's range of Melamine platters include reversible Slate/Granite platters, showcasing a matt slate effect finish on one side and a glossy granite effect on the other.



Reversible Slate/Granite Platter GN 1/3
JMP232 32.5 x 17.5cm (12.75 x 7")
 Box of 6



Unique resin for tabletop & buffet

Kenny Mack Designs features a durable & break resistant resin that is ideal for commercial foodservice. With a multitude of shapes, colours, and sizes, this collection combines functional form and reliability. Inclusive of serving bowls, platters, trays, risers, and more, Kenny Mack resin will elevate any buffet presentation.

Wave



Wave Condiment Bowl
Tortoise
KMK1028TOR
12.1 x 7cm 22.7cl
(4 ¾ x 2 ¾" 8oz)
Box of 6



Wave Condiment Bowl
Tangerine Pearl
KMK1028TGP
12.1 x 7cm 22.7cl
(4 ¾ x 2 ¾" 8oz)
Box of 6



Wave Condiment Bowl
Shell
KMK1028SH
12.1 x 7cm 22.7cl
(4 ¾ x 2 ¾" 8oz)
Box of 6



Wave Condiment Bowl
Marine Blue Pearl
KMK1028MBP
12.1 x 7cm 22.7cl
(4 ¾ x 2 ¾" 8oz)
Box of 6

Scoop



Scoop Bowl
Tangerine Pearl
KMK1019TGP
34.29 x 15.24cm 9L
(13 ½ x 6" 2 gal)
Box of 1



Scoop Bowl
Tangerine Pearl
KMK1018TGP
24.13cm x 12.7cm 2.8L
(9 ½ x 5" 3qt)
Box of 2



Scoop Bowl Shell
KMK1019SH
34.29 x 15.24cm 9L
(13 ½ x 6" 2 gal)
Box of 1



Scoop Bowl Shell
KMK1018SH
24.13cm x 12.7cm 2.8L
(9 ½ x 5" 3qt)
Box of 2



A deliciously dark development of our hugely popular Vintage Steel Collection. This Black colourway takes the most versatile pieces and gives them a stunning new look.



Black Vintage Steel Oval Dish
F91424 24.5 x 17.5cm (9.5 x 7")
 Box of 6



Black Vintage Steel Oval Dish
F91425 16.5 x 12.5cm (6.5 x 5")
 Box of 6



Black Vintage Steel Mini Casserole Dish
F91427 12.25cm (5")
 Box of 6



Black Vintage Steel Mini Casserole Dish
F91426 9cm (3.5")
 Box of 6



Black Vintage Steel Mini Sauce Pan
F91423 9cm (3.5")
 Box of 6
F91422 7cm (2.75")
 Box of 6



Black Vintage Steel Mini Fry Pan
F91421 15.5cm (6")
 Box of 6



Black Vintage Steel Hammered Chip Cup
F91420 8.5cm (3.5")
 Box of 12



Black Vintage Steel Ramekin
F91428 7cl (2.5oz)
 Box of 24
F91429 4cl (1.5oz)
 Box of 24

These additions to the Vintage Steel Collection bring further versatility to this authentic range.



Vintage Steel Brass Handled Oval Dish
F91413 24.5 x 17.5cm (9.5 x 6.75")
 Box of 6
F91414 16.5 x 12.5cm (6.5 x 5")
 Box of 6



Vintage Steel Brass Handled Dish
F91405 23cm (9")
 Box of 6



Vintage Steel Brass Handled Dish
F91404 19.5cm (7.5")
 Box of 6
F91403 15cm (6")
 Box of 6



Vintage Steel Mini Casserole Dish
F91408 12.25cm (5")
 Box of 6



Vintage Steel Mini Casserole Dish
F91409 9cm (3.5")
 Box of 6



Vintage Steel Mini Fry Pan
F91410 15.5cm (6")
 Box of 6



Vintage Steel Mini Sauce Pans
F91412 9cm (3.5")
 Box of 6
F91411 7cm (2.75")
 Box of 6



Vintage Steel Hammered Chip Cup
F91401 8.5cm 47.5cl (3.5" 16.75oz)
 Box of 12



Vintage Steel Chip Cup
F91400 8.5cm 47.5cl (3.5" 16.75oz)
 Box of 12



Vintage Steel Ramekin
F91415 6 x 4.3cm H 7cl (2.5oz)
 Box of 24
F91416 6 x 2.6cm H 4cl (1oz)
 Box of 24



Vintage Steel Dip Bowl
F91402 8cm 10cl (3" 3.5oz)
 Box of 24



Vintage Steel Coupe Plate
F91419 15cm (6")
 Box of 6



Vintage Steel Tray
F91407 33 x 23cm (13 x 9")
 Box of 6



Vintage Steel Tray
F91406 23 x 16.5cm (9 x 6.5")
 Box of 6



Vintage Steel Pie Dish
F91418 20 x 14cm (7.85 x 5.5")
 Box of 6



Vintage Steel Pie Dish
F91417 18 x 13.5cm (7 x 5.3")
 Box of 6



Vintage Steel Pie Dish
F91431 16 x 12cm (6.3 x 4.75")
 Box of 6





Elevate your creations with this unique riser that is available with three different heights of base allowing you to tier your presentation to suit the environment. These Round Top Risers are compatible with Dome Cover 6471ML15.



Round Pedestal Top
68A340EL566
29cm (11 1/2")
Box of 1



Pedestal for Round Top
68A340EL567
7.6cm (3") H
Box of 1



Pedestal for Round Top
68A340EL568
12.7cm (5") H
Box of 1



Pedestal for Round Top
68A340EL569
17.8cm (7") H
Box of 1

Dome Cover



Dome Cover
6471ML15 29cm (11 1/2")
Compatible with Round Top Risers
Box of 1

Hepp

HEPP Risers & Stands

Top restaurants around the world draw on the HEPP repertoire to present exquisite dishes in perfect style. Create a unique atmosphere with our buffet range - from a relaxed start to the day to an exceptional gourmet experience in the evening. Whether a single eye-catcher or a multi-layered composition, HEPP meets even the highest demands for an exclusive hot and cold buffet. Elegant surfaces meet a striking design language and sophisticated functionality.



Neutral 3-Tier Multi Purpose Stand SS
50161317
40cm (15 3/4")
Box of 1



Neutral 3-Tier Multi Purpose Stand
50161187
25.4cm H (10" H) Fits 16cm Plate
Box of 1



Excellent 3-Tier Multi Purpose Stand For 21cm Plate SS
51471254
44.7cm (17 3/8")
Box of 1



Excellent 2-Tier Pastry Stand
51471375
22.3cm (8 7/8") H
Box of 1



Excellent 3-Tier Pastry Stand
51471064
32cm (12 5/8") H
Box of 1



Fleur Large Buffet Stand SS
52361096
21cm (8 1/4")
Box of 1



Fleur Medium Buffet Stand SS
52361095
13.6cm (5 1/2")
Box of 1



Fleur Small Buffet Stand SS
52361094
9.8cm (3 7/8")
Box of 1



Elevate your presentation with seafood stands

Elevate your presentation with seafood stands by Williamsburg Metalworks. These unique, custom designed stands are made in the USA and provide versatility with their multi-tiered options. Made of highly durable, heavy gauge 18/8 stainless steel, these stands are easy to disassemble and are dishwasher safe. Bringing your presentations to new heights, it's the perfect solution for an impressive tabletop.



Black Powder Coated 2-Tier Seafood Stand w/ Removable Drain Plates
Straight Sided
5856JX01
31 x 23cm H (12 ¼ x 9" H)
Tier 1 - 30.5cm (12"),
Tier 2 - 25.5cm (10")
Box of 1



Black Powder Coated 3-Tier Seafood Stand w/ Removable Drain Plates
Straight Sided
5856JX00
31 x 39.4cm H (12 ¼ x 15 ½" H)
Tier 1 - 30.5cm (12"),
Tier 2 - 25.5cm (10"),
Tier 3 - 20.25cm (8")
Box of 1



The versatile Seafood Tower can be used as an eye-catching statement serve piece or broken down into it's individual parts for a variety of uses.

Vintage Steel



Vintage Steel Large Stand
F91509
19.5 x 15.5cm (7.5 x 6")
Box of 1



Vintage Steel Small Stand
F91508
18 x 12.5cm (7 x 5")
Box of 1



Vintage Steel Serving Bowl
F91507 35cm (13.75")
Box of 1



Vintage Steel Serving Bowl
F91506 29.5cm (11.5")
Box of 1



Vintage Steel Serving Bowl
F91505 24.5cm (9.5")
Box of 1

Vintage Gold



Vintage Gold Large Stand
F91514
19.5 x 15.5cm (7.5 x 6")
Box of 1



Vintage Gold Small Stand
F91513
18 x 12.5cm (7 x 5")
Box of 1



Vintage Gold Serving Bowl
F91512 35cm (13.75")
Box of 1



Vintage Gold Serving Bowl
F91511 29.5cm (11.5")
Box of 1



Vintage Gold Serving Bowl
F91510 24.5cm (9.5")
Box of 1



Shown with F41420 Black Vintage Steel Cup



Shown with F17017 Copper Hammered Cup

Vintage Black



Vintage Black Large Stand
F91519 19.5 x 15.5cm (7.5 x 6")
Box of 1



Vintage Black Small Stand
F91518 18 x 12.5cm (7 x 5")
Box of 1



Vintage Black Serving Bowl
F91517 35cm (13.75")
Box of 1



Vintage Black Serving Bowl
F91516 29.5cm (11.5")
Box of 1



Vintage Black Serving Bowl
F91515 24.5cm (9.5")
Box of 1

Vintage Copper



Vintage Copper Large Stand
F91524 19.5 x 15.5cm (7.5 x 6")
Box of 1



Vintage Copper Small Stand
F91523 18 x 12.5cm (7 x 5")
Box of 1



Vintage Copper Serving Bowl
F91522 35cm (13.75")
Box of 1



Vintage Copper Serving Bowl
F91521 29.5cm (11.5")
Box of 1



Vintage Copper Serving Bowl
F91520 24.5cm (9.5")
Box of 1

Stainless Steel



Large Serving Stand
F91504 19.5 x 15.5cm (7.5 x 6")
Box of 1



Small Serving Stand
F91503 18 x 12.5cm (7 x 5")
Box of 1



Seafood Tower Serving Bowl
F91502 35cm (13.75")
Box of 1



Seafood Tower Serving Bowl
F91501 29.5cm (11.5")
Box of 1



Seafood Tower Serving Bowl
F91500 24.5cm (9.75")
Box of 1



A completely unique and creative serve option. Finished in aged copper to bring a touch of timeless elegance and rustic feel, our Birdcage stand is perfect for a quirky afternoon tea set up. Mix it up with Darwin boards for a truly individual presentation. Or add any 23cm plates for versatile use.

Our Vintage Birdcage Presentation Stand is the ultimate statement piece to create a wow moment. Present as an afternoon tea serve or simply a sharing platter. Finished in aged black, this serve ware option exudes opulence.



Birdcage Plate Stand
CT7018
 47 x 25cm (18.5 x 10")
 Holds 3 x 23cm Plates
 Box of 1



Vintage Birdcage Presentation Stand
CT7019
 43 x 22cm (17 x 8.75")
 Box of 1



3 Tier Slate Platter
CT0041
 30, 25, 20cm (12, 10, 8")
 Box of 1

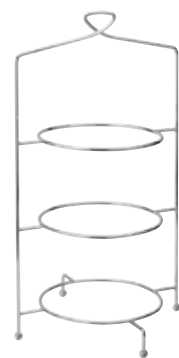

Savoy 3 Tier Plate Stand
F91201 46cm (18")
 Holds 3 x 23cm plates
 Box of 1

The revival of a classic British pastime can be seen in the ever growing trend for Afternoon Tea. This quintessentially British activity offers the opportunity to indulge.

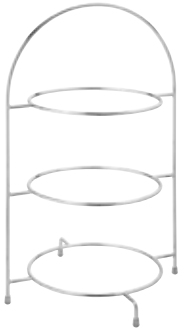

Chrome 3 Tier Plate Stand
F91032 43cm (17")
 Holds 3 x 25cm plates
 Box of 1

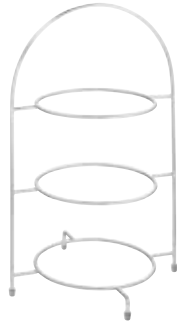

Chrome 3 Tier Plate Stand
F91006 42cm (16.5")
 Holds 3 x 23cm plates
 Box of 1

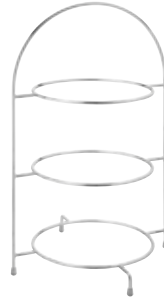

Chrome 3 Tier Plate Stand
F91005 39cm (15.5")
 Holds 3 x 17cm plates
 Box of 1



Chrome 2 Tier Plate Stand
F91202 32cm (12.5")
 Holds 2 x 23cm plates
 Box of 1



Gold 3 Tier Plate Stand
F92006 42cm (16.5")
 Holds 3 x 23cm plates
 Box of 1



Gold 3 Tier Plate Stand
F92032 43cm (17")
 Holds 3 x 25cm plates
 Box of 1

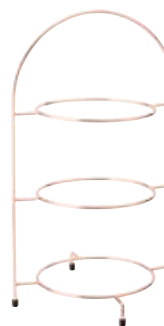

Copper 3 Tier Plate Stand
F91203 42cm (16.5")
 Holds 3 x 23cm plates
 Box of 1



Copper 3 Tier Plate Stand
F91204 43cm (17")
 Holds 3 x 25cm plates
 Box of 1

William Edwards
Plate Stands



Elevate your tabletop

A charming centrepiece for pastries or afternoon tea, these elegant tea stands from William Edwards are guaranteed to impress. Exquisitely crafted from polished stainless steel, a striking collection of tri-level and two-tiered designs stand to magnificently adorn a luxurious dining or serving table.

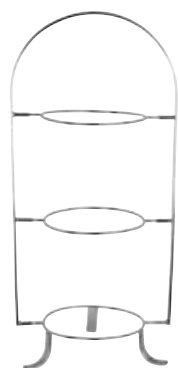

Large 3-Tier Tea Stand
82000AND10LS 47.5cm H
 (Fits 21-22cm Plate)
 Box of 1

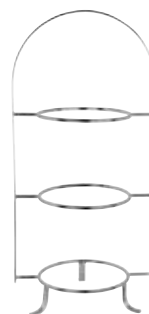

Small 3-Tier Tea Stand
82000AND10SS 40.5cm H
 (Fits 16-17cm Plate)
 Box of 1



2-Tier Plate Stand
82000AND102T 12cm H
 (Fits 16-17cm Plate)
 Box of 1



Wonderfully versatile, these Plate Risers work equally well as part of a counter-top display or as a table serve to elevate presentation.



Gold Plate Riser
F92033
Top Dia. 19 x 15.5cm H (7.5")
Box of 6



Gold Plate Riser
F92034
Top Dia. 16.5 x 13cm H (6.5 x 5" H)
Box of 6



Chrome Plate Riser
F92035
Top Dia. 19 x 15.5cm H (7.5")
Box of 6



Chrome Plate Riser
F92036
Top Dia. 16.5 x 13cm H (6.5 x 5" H)
Box of 6



Copper Plate Riser
F92037
Top Dia. 19 x 15.5cm H (7.5")
Box of 6



Copper Plate Riser
F92038
Top Dia. 16.5 x 13cm H (6.5 x 5" H)
Box of 6



Matt Black Plate Riser
F92039
Top Dia. 19 x 15.5cm H (7.5")
Box of 6



Matt Black Plate Riser
F92040
Top Dia. 16.5 x 13cm H (6.5 x 5" H)
Box of 6



The Patisserie dome and footed plate are ideal for counter top display but also make a perfect centrepiece for afternoon tea.



Patisserie Dome & Stand
P95200 30.75 x 15cm H (12 x 6" H)
 Box of 1
 Patisserie Uprturned Footed Plate
P95117 32 x 15cm H (12.5 x 6" H)
 Box of 2



Vintage Cake Dome & Stand
R90004 30 x 27cm H (12 x 10.5" H)
 Sold as a set
 Box of 1



Plastic Cake Dome
HD0863 28 x 12cm H (11" x 4.5" H)
 Box of 6



Sophia Plastic Cake Dome
HD0873 32.5 x 16.5cm (12.75 x 6.5" H)
 Box of 6



Aura 3 Tiered Square
 Glass Plate
R90058
 24.5, 20, 14.5cm
 (9.75, 8, 5.75")
 Box of 1



Aura 2 Tiered Rectangular
 Glass Plate
R90056
 30 x 20.5cm, 16 x 14cm
 (11.75 x 8", 10.25 x 5.75")
 Box of 1





Asos White Footed Plate
R20110 28 x 13cm (11 x 5.25")
Box of 1



Asos White Plate
R20106 21cm (8.25")
Box of 6



Asos Pink Footed Plate
R20109 28 x 13cm (11 x 5.25")
Box of 1



Asos Pink Plate
R20107 21cm (8.25")
Box of 6



Asos Black Plate
R20108 21cm (8.25")
Box of 6

Hollow



Hollow White Bowls
R20103 15cm (6")
Box of 4
R20102 10cm (4")
Box of 6



Hollow Pink Bowl
R20105 15cm (6")
Box of 4
R20104 10cm (4")
Box of 6



Hollow Black Bowl
R20101 15cm (6")
Box of 4
R20100 10cm (4")
Box of 6



Hill White Dip Bowl
R20111 10cm (4")
Box of 4



Hill Black Dip Bowl
R20112 10cm (4")
Box of 4

Hill



Hollowware & Accessories

Whether it's coffee or water service, canapés or finger sandwiches, your tabletop deserves quality stainless steel hollowware from Steelite-Utopia. Our collections perfectly pair with any existing items, and offer a variety of accessory pieces to ensure your table & room service are complete.

Hepp



HEPP Hollowware



Hepp's exquisite coffee and tea collection meets even the highest demands. Elegant pots, stylish sugar bowls and numerous accessories enhance your table presentation both aesthetically and functionally. Impress your guests with luxurious details that underline your gastronomic excellence thanks to numerous customisation options.



Neutral Double Walled Coffee Pot SS
50161246
0.3L (11oz)
Box of 1



Neutral Double Walled Coffee Pot SS
50161247
0.6L (21oz)
Box of 1



Neutral Double Walled Coffee Pot SS
50161248
1.2L (42oz)
Box of 1



Neutral Doubled Walled Milk Jug SS
50161884
15cl (5oz)
Box of 1



Neutral Double Walled Tea Pot With Strainer SS
50161525
1.2L (42oz)
Box of 1



Neutral Double Walled Tea Pot With Strainer SS
50161524
0.6L (21oz)
Box of 1



Neutral Tea Strainer with Drip Stand
50161046
16.8 x 6.7 x 2.6cm (6 5/8 x 2 2/5 x 1")
Box of 1



Excellent Coffee Pot SS
51471276
60cl (21oz)
Box of 1



Excellent Coffee Pot SS
51471246
0.3L (11oz)
Box of 1



Excellent Teapot SS
51471701
70cl (25oz)
Box of 1



Excellent Teapot SS
51471708
0.35L (12oz)
Box of 1



Excellent Milk Jug SS
51471308
30cl (11oz)
Box of 1



Excellent Milk Jug SS
51471307
0.15L (5oz)
Box of 1



Excellent Sugar Bowl SS
51471310
25cl (9oz)
Box of 1



Excellent Sauce Boat SS
51471335
20cl (7oz)
Box of 1



Profile Coffee Pot
51575096
15.2cm 0.6Ltr (6" 20 1/2oz)
Box of 1



Profile Coffee Pot
51575095
11.6cm 0.3Ltr (4 1/2" 10 1/2oz)
Box of 1



Profile Ice Water Jug
51575099
21.3cm 2Ltr (9" 67 5/8oz)
Box of 1



Profile Milk Jug
51575098
9.7cm 0.3Ltr (3 7/8" 10 1/2oz)
Box of 1



Profile Milk Jug
51575097
9.4cm 0.15Ltr (3 5/8" 5oz)
Box of 1



Profile Sugar Bowl with Lid
51575100
8.6cm 0.3Ltr (3 3/8" 10 1/2oz)
Box of 1

Hepp



HEPP Accessories



Neutral Round Fruit Basket
50161250
20.5cm (8")
Box of 1



Neutral Toothpick Stand SS
50161942
8cm (3 1/4")
Box of 1



Neutral Wood Black Salt Mill
50161258
13.5cm (5 1/2")
Box of 1



Neutral Wood Black Pepper Mill
50161259
13.5cm (5 1/2")
Box of 1



Neutral Salt Shaker
50161526
7cm (2 3/4") H
Box of 1



Neutral Pepper Shaker
50161527
7cm (2 3/4") H
Box of 1



Excellent Sugar Server
51471403
9cm (3 1/2") Dia Per Dish
Box of 1



Excellent 2-Part Butter Dish SS
51471237
9cm (3 1/2")
Box of 1



Excellent Dome Cover SS
51471312
27.2cm (10 3/4")
Box of 1



Neutral Round Service Tray
50161262
36.9cm (14 1/2")
Box of 1



Neutral Serving Tray
50161263
30.5 x 25.4cm (12 x 10")
Box of 1



Profile Candelabra
51571240
28.6cm (11 1/4") H
Box of 1



Neutral 3-Tier Multi Purpose
Stand SS
50161317
40cm (15 3/4")
Box of 1



Neutral 3-Tier Multi Purpose
Stand
50161187
25.4cm H (10" H) Fits 16cm Plate
Box of 1



Excellent 3-Tier Multi Purpose
Stand For 21cm Plate SS
51471254
44.7cm (17 5/8")
Box of 1



Excellent 3-Tier Pastry Stand
51471064
32cm (12 5/8") H
Box of 1



Excellent 2-Tier Pastry Stand
51471375
22.3cm (8 7/8") H
Box of 1



Fleur Large Buffet Stand SS
52361096
21cm (8 1/4")
Box of 1



Fleur Medium Buffet Stand SS
52361095
13.6cm (5 1/8")
Box of 1



Fleur Small Buffet Stand SS
52361094
9.8cm (3 7/8")
Box of 1



Dante Dash Bottles
R90243
 15cl (5.25oz) H 145mm
 Pourers: R90249, R90250,
 R90246
 Box of 6



Nostalgia Dash Bottle
R90263
 15cl (5.25oz) H 155mm
 Pourer: R90264
 Box of 6



Bitters Bottle Gold Top
R90266
 10cl (3.5oz) H 145mm
 Box of 6



Bitters Bottle Copper Top
R90265
 10cl (3.5oz) H 145mm
 Box of 6



Bitters Bottle Stainless Steel Top
R90262
 10cl (3.5oz) H 145mm
 Box of 6



Copper Tapered Free Flow Pourer
F93029
 H 28mm
 Box of 6



Chrome Tapered Free Flow Pourer
F91089
 Box of 12



Small Spare Pourer
R90264
 For opening 1.75cm
 Box of 6



Spare Pourer for Dash Bottles
R90246
 For opening 2cm
 Box of 12



Gold Dash Pourer
R90250
 For opening 2cm
 Box of 12



Copper Dash Pourer
R90249
 For opening 2cm
 Box of 12

Squeezy Bottles

- Designed with a wide neck and screw top for easy, no spills refills
- Break resistant plastic
- Perfect for front of house but also ideal for food preparation

Clear Squeezy Sauce Bottle
F61015 23cl (8oz)
 Box of 12
F61016 34cl (12oz)
 Box of 12
F61018 68cl (24oz)
 Box of 12
F61019 96cl (32oz)
 Box of 12





Condiment Holder
4 Inserts
F91102
30cm (11.75")
Box of 1

Condiment Holder
5 Inserts
F91103
37cm (14.5")
Box of 1

Condiment Holder
6 Inserts
F91104
44.5cm (17.5")
Box of 1



Copper Condiment Holder
4 Inserts
F91161
30cm (11.75")
Box of 1

Copper Condiment Holder
6 Inserts
F91162
44.5cm (17.5")
Box of 1



Copper Bar Caddy
F93050
24.6 x 11cm H (9.7 x 4.5" H)
Box of 1



Copper Napkin Holder
F91174
13.5 x 11cm H (5.4")
Box of 1



Stainless Steel Napkin Holder
F91175
13.5 x 11cm H (5.4")
Box of 1



The warm natural tones of these beautifully crafted Acacia Wood Table Caddies are the perfect addition to the well dressed table. Created from a sustainable source they are an ideal way to present a range of tabletop items including condiments, cutlery and menus.



Acacia Handled
Table Caddy
JMP701
20.8 x 14.2 x 10.75cm
(8.2 x 5.5 x 4.25")
Box of 2



Acacia 2 Compartment
Table Caddy
JMP700
18 x 10.2 x 12cm
(7 x 4 x 4.75")
Box of 2



Black Wooden Table Caddy

Holds bottles up to 6cm diameter.



Large Black Wooden Table Caddy
JMP708
25 x 15.8 x 18cm
(9.85 x 6.25 x 7")
Box of 2



Medium Black Wooden Table Caddy
JMP709
20 x 15.3 x 18cm
(7.85 x 6 x 7")
Box of 2



Small Black Wooden Table Caddy
JMP710
14.5 x 14.7 x 15cm
(5.7 x 5.75 x 6")
Box of 2

Wooden Table Caddy

Holds bottles up to 6cm diameter.



Large Wooden Table Caddy
JMP705
25 x 15.8 x 18cm
(9.85 x 6.25 x 7")
Box of 2



Medium Wooden Table Caddy
JMP706
20 x 15.3 x 18cm
(7.85 x 6 x 7")
Box of 2



Small Wooden Table Caddy
JMP707
14.5 x 14.7 x 15cm
(5.7 x 5.75 x 6")
Box of 2

White Wooden Table Caddy

Holds bottles up to 6cm diameter.



Large White Wooden Table Caddy
JMP711
25 x 15.8 x 18cm
(9.85 x 6.25 x 7")
Box of 2



Medium White Wooden Table Caddy
JMP712
20 x 15.3 x 18cm
(7.85 x 6 x 7")
Box of 2



Small White Wooden Table Caddy
JMP713
14.5 x 14.7 x 15cm
(5.7 x 5.75 x 6")
Box of 2

Rustic Wooden Table Caddy

Holds bottles up to 6cm diameter, Paulownia Wood.



Large Rustic Wooden Table Caddy
JMP702
25 x 15.8 x 18cm
(9.85 x 6.25 x 7")
Box of 2



Medium Rustic Wooden Table Caddy
JMP703
20 x 15.3 x 18cm
(7.85 x 6 x 7")
Box of 2



Small Rustic Wooden Table Caddy
JMP704
14.5 x 14.7 x 15cm
(5.7 x 5.75 x 6")
Box of 2



Our 100% FSC approved birch wood cutlery are easy to handle and Eco-Friendly. Fully biodegradable disposable wooden cutlery can be used with both hot and cold foods. Perfect for takeaway, outdoor events and for environmentally driven venues.



Economy Wooden Cutlery



Natural Sugarcane Cutlery

This range, crafted from sugarcane, represents our commitment to environmentally friendly alternatives in the hospitality industry. The collection is designed with expertly engineered ridges to enhance strength and durability. These ridges ensure that our cutlery stands up to the rigorous demands of hospitality use, while being a single-use, eco-conscious choice.



Sugarcane Knife
F90241 16.5cm (6.5")
10 Boxes of 100



Sugarcane Fork
F90240 16.5cm (6.5")
10 Boxes of 100



Sugarcane Spoon
F90242 14.5cm (5.75")
10 Boxes of 100

Compostable Paper Cutlery

Designed with hospitality in mind, this range boasts a robust design, featuring nine layers to ensure strength and practicality. Each item is fully biodegradable and compostable.

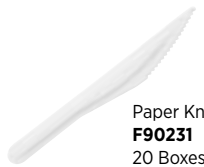

Paper Knife
F90231 15.8cm (6.25")
20 Boxes of 50



Paper Fork
F90230 15.8cm (6.25")
20 Boxes of 50



Paper Spoon
F90232 15.8cm (6.25")
20 Boxes of 50

Skewers

Practical and attractive, these skewers are ideal for livening up everything from cocktails to burgers, a must have in the Bar or Kitchen.



Knot Bamboo Skewer
JMP990 9cm (3.5")
10 Packs of 100



Knot Black Bamboo Skewer
JMP861 9cm (3.5")
10 Packs of 100



Knot Red Bamboo Skewer
JMP865 9cm (3.5")
10 Packs of 100



Curly Black Bamboo Skewer
JMP867 9cm (3.5")
10 Packs of 100



Bamboo Black Knotted Skewer
JMP862 12cm (5")
10 Packs of 100



Curly Bamboo Skewer
JMP978 12cm (4.75")
10 Packs of 100



Curly Black Bamboo Skewer
JMP868 12cm (5")
10 Packs of 100



Bamboo Ball Skewer
JMP873 12cm (5")
10 Packs of 100



Teppo Bamboo Skewer
JMP989 12cm (4")
10 Packs of 100



Vegan Flag Skewer
JMP876 6cm (2.5")
10 Packs of 100



Nude • Crystal Glassware

Carafes





Nude ◦ Crystal Glassware

Carafes



Melodia



Halo Carafe
P20933
1.25L (44oz) H 298mm
Box of 6



Vini Carafe Handmade
P38451
1.75L (59oz) H 266mm
Box of 2



Pure Carafe
P28749
75cl (26.25oz) H 251mm
Box of 6



Rona ◦ Crystal Glassware

Carafes



Carafe
L2821-7200
0.5L H 230mm
Box of 1



RCR Cristalleria ◦ Crystal Glassware

Carafes



Melodia Carafe - No Lid
670RCR356
1L (40.75oz)
H 270mm Ø max 90mm
Box of 4

Carafes



 Exclusiva Carafe **NEW**
49910Q746
1L (35.5oz)
H 255mm (10")
Ø 102mm (4")
Box of 6



 Exclusiva Carafe **NEW**
49910Q847
0.25L (8.75oz)
H 165mm (6 ½")
Ø 67mm (2 ⅝")
Box of 12



 Exclusiva Carafe **NEW**
49910Q947
0.5L (17.5oz)
H 204mm (8")
Ø 83mm (3 ¼")
Box of 6



Italian Heritage Carafe **NEW**
49162Q808
1L (35.25oz)
H 277mm (10 ⅞")
Ø 91.5mm (3 ⅝")
Box of 6



Officina Carafe
49119Q924
1L (35.25oz)
H 275mm (10 ¾")
Ø 96mm (3 ¾")
Box of 6



Officina Carafe
49119Q937
50cl (17.5oz)
H 227mm (8 ⅞")
Ø 81mm (3 ¼")
Box of 12



Officina Carafe
49119Q938
25cl (8.75oz)
H 180mm (7 ⅛")
Ø 66mm (2 ⅝")
Box of 12



Misura PZ Carafe
4929Q202
1L (35.25oz)
H 261.7mm (10 ¼")
Ø 108mm (4 ¼")
Box of 6



Misura PZ Carafe
4929Q201
50cl (17.5oz)
H 234.7mm (9 ¼")
Ø 84mm (3 ¼")
Box of 12



Misura PZ Carafe
4929Q200
25cl (8.75oz)
H 190.2mm (7 ½")
Ø 68.5mm (2 ¾")
Box of 12



Ultra-hip design

The Ypsilon collection features an ultra-hip design inspired by Europe's trendiest bars and nightclubs. The striking V-shape form is as stylish as it is functional, providing a heavier base for extra stability and pleasing aesthetics.



Ypsilon Jug
4945Q412
1Ltr (35.25oz)
H 255mm (10")
Ø 102mm (4")
Box of 6



Ypsilon Jug
4945Q414
55cl (19.25oz)
H 204mm (8")
Ø 83mm (3 ¼")
Box of 6



Ypsilon Jug
4945Q415
28cl (9.75oz)
H 165mm (6 ½")
Ø 67mm (2 ¾")
Box of 12



Ypsilon Cork Lid 1L
4945Q646
Fits 4945Q412
Box of 12
Ypsilon Cork Lid 50cl
4945Q647
Fits 4945Q414
Box of 24
Ypsilon Cork Lid 25cl
4945Q648
Fits 4945Q415
Box of 24



Ypsilon Wine Carafe
4945Q939
1L (35.25oz)
H 215mm (8 ½")
Ø 115mm (4 ½") CE Mark
Box of 6



Ypsilon Wine Carafe
4945Q941
50cl (17.5oz)
H 171mm (6 ¾")
Ø 93mm (3 ⅝") CE Mark
Box of 6



Ypsilon Wine Carafe
4945Q940
25cl (8.75oz)
H 140mm (5 ½")
Ø 73.5mm (2 ⅞") CE Mark
Box of 12



Crown Glassware



Authentico



Cobalt
Contemporary
Carafe
R90106
1L H 255mm
Box of 6



 Contemporary
1 Litre Carafe
B25000
H 255mm
Box of 6



 Contemporary
0.5 Litre Carafe
B25080
H 204mm
Box of 6



 Contemporary
0.25 Litre Carafe
B25070
H 165mm
Box of 12



Contemporary
Carafes
R90108
11cl (4oz)
H 120mm
Box of 12



1L Symphony Carafe
R382104
1L (35oz) H 278mm
4 Boxes of 6



1L Carafe
R301101
1L (35oz) H 270mm
Box of 6



0.5L Carafe
R301102
0.5L (17.5oz) H 200mm
Box of 6



Elysia Carafe
P80403
94cl (33oz) H 265mm
Box of 6



Timeless Vintage Carafe
P80402
94cl (33oz) H 265mm
Box of 6



Amphora Carafe
P43813
118cl (41oz) H 249mm
Box of 6



Amphora Carafe
P43853
35cl (12.25oz) H 172mm
Box of 12



Village Carafe
P43824
1 Litre (35oz) H 250mm
Box of 6



Village Carafe
P43814
0.5 Litre (17.5oz) H 205mm
Box of 6



Village Carafes
P43804
0.25 Litre (8.75oz) H 170mm
Box of 12



Mini Village Carafes
P43818
10cl (7oz) H 122mm
Box of 12



Carafe
P80111
1 Litre H 262mm
Box of 6



Carafe
P80113
0.5 Litre H 213mm
Box of 6



Barca Carafe
S20107
1L H 252mm
Box of 6



Authentico Bottle
S20113
1L H 285mm
Box of 6



Authentico Carafe
S20170
28oz (80cl) H 252mm
Box of 6



Authentico Ribbed
Pitcher **NEW**
S20172
2.3L
H 200mm Ø 200mm
Box of 6



The Contemporary Pitchers offer superb clarity in a modern and elegant shape. With two sizes the pitchers are ideal for serving wine, water or juices in a stylish way.



Contemporary Pitcher
L61534-5100
2L (70oz) H 300mm
Box of 1



Contemporary Pitcher
L61534-4900
1L (33.75oz) H 265mm
Box of 1



Nude ◦ Crystal Glassware

Hemingway

Part of the Nude Hemingway collection, the streamlined silhouette features a short spout, a sculptural handle and a sharp linear pattern for a distinct look that stands the test of time.



Hemingway 1L Jug
P68010
H 225mm
Box of 1



Bistro Jugs



Eternal Jug
R90183
1.5 Litre
H 220mm
Box of 6



Dante Jug
R98016
110cl (39oz)
H 206mm
Box of 6



Studio Jugs
C90004
1.3 Litre H 210mm
Box of 6



Studio Jugs
C90003
1 Litre H 200mm
Box of 6



Ice Lipped Waisted
R80201
3 Pint H 225mm
Box of 6



Timeless Vintage Jug
P55332
144cl (48oz) H 215mm
Box of 6



Niagra Jug
P43864
4 Pint H 250mm
Box of 6
P43864-LCA
4 Pint L@2,3,4 pints CE
H 250mm
Box of 6



Conic
P55102
1.8L (3 Pint) H 232mm
Box of 6



Bistro Jug
P80119
1.8 Litre H 235mm
Box of 6



Bistro Jug
P80102
1 Litre H 200mm
Box of 6



Bistro Jug
P80100
0.25 Litre H 120mm
2 Boxes of 12



Bistro Jug
P80100
0.25 Litre H 120mm
2 Boxes of 12



Bormioli Rocco • Glassware

Pitchers Jugs & Bottles



Romantic Pitcher
49123Q889
190cl (67oz) Brimful
H 236mm (9 ¼")
Ø 171.5mm (6 ¾")
Box of 6



Bistrot Jug
4971Q599
1L (35.25oz) Brimful
H 186.5mm (7 ¼")
Ø 149.5mm (6")
Box of 6



Bistrot Jug
4971Q601
50cl (17.5oz) Brimful
H 144.5mm (5 ¾")
Ø 126.5mm (5")
Box of 12



Bistrot Jug
4971Q691
25cl (8.75oz) Brimful
H 117.4mm (4 ½")
Ø 102mm (4")
Box of 12

Aqua

Sustainable glass bottles

These screw top bottles are suitable for sparkling water and enhance the appearance of any beverage with their organic design. The glass bottle is dishwasher safe, the cap should be washed by hand. For correct usage fill to a maximum of 5cm from the brim.



Aqua Bottle
49204Q960
1L (35.25oz)
H 28.1cm (11 ⅛")
Ø 8.9cm (3 ½")
Box of 6



Aqua Bottle
49204Q959
75cl (26.5oz)
H 25.7cm (10 ⅛")
Ø 8.2cm (3 ¼")
Box of 6



Vertis Bottle
R90612
1L H 290mm
Box of 6



Atlantis Lidded Water
Bottle
R90029
1L H 275mm
Box of 12
Spare lid
R90125 Box of 6



Atlantis Lidded Water
Bottle
R90028
0.5L H 225mm
Box of 12
Spare lid
R90126 Box of 6



Atlantis Lidded Water
Bottle
R90027
0.25L H 170mm
Box of 12
Spare lid
R90126 Box of 6



Iconic Bottle
P80401
35cl (12.25oz)
H 178mm
Box of 6



Era Lidded Bottle
R91001
0.75L H 235mm
Box of 6
Spare Lid
R90003 Box of 12



Era Lidded Bottle
R91000
0.5L H 190mm
Box of 12
Spare Lid
R90003 Box of 12



Lidded Bottle
R90111
1L (35oz) H 260mm
Box of 12



Lidded Bottle
R90112
0.5L (17.5oz) H 205mm
Box of 12



Pint Milk Bottle
R90119
58cl (20oz) H 185mm
Box of 12



Mini Milk Bottle
R90059
12cl (4.25oz) H 105mm
Box of 6



Italian Heritage

Textures typical of Italian tradition

Modern shapes are combined with rich glass decoration to emphasise their brilliance. This is a texture reminiscent of majolica, a great Italian tradition dating back to the Renaissance.



Italian Heritage Bottle
NEW
49162Q805
1L (35.25oz)
H 307mm (12 1/8")
Ø 91.5mm (3 5/8")
Box of 6



Italian Heritage Bottle
NEW
49162Q819
0.5L (17.5oz)
H 253.8mm (10")
Ø 72.9mm (2 7/8")
Box of 6

Officina

Bringing a unique vintage look to the tabletop with its embossed stamp and textured rings, Officina has provided an exceptional charm to the overall tabletop presentation. Complete with a handle around the neck of the bottle for ease of handling.



Officina Bottle
49119Q068
1L (35.25oz)
H 290mm (11 1/2")
Ø 94mm (3 3/4")
Box of 6



“Go green” in any venue with swing top bottles

An extension of Steelite-Utopia’s continued commitment to our environment, this eco-friendly product is sure to impress. These glass vessels are not only ideal for water, but make for a unique display of house wine, specialty juices and delectable oils.



Moresca Bottle
4953Q512
 1L (35.25oz)
 H 306mm (12")
 Ø 88mm (3 ½")
 Box of 20



Giara Bottle
4952Q819
 50cl (17.5oz)
 H 253mm (10")
 Ø 70mm (2 ¾")
 Box of 12



Giara Bottle
4952Q863
 1L (35.25oz)
 H 306mm (12")
 Ø 86mm (3 ½")
 Box of 6



Oxford Bottle
4952Q805
 1L (35.25oz)
 H 306.5mm (12")
 Ø 89.2mm (3 ½")
 Box of 6



Swing Bottle
4953Q896
 1L (35.25oz)
 H 315mm (12 ½")
 Ø 82mm (3 ¼")
 Box of 6



Swing Bottle
4953Q675
 50cl (17.5oz)
 H 253mm (10")
 Ø 77mm (3")
 Box of 12



Square Swing Bottle

Italian Heritage



Moresca Bottle
B45930
 1 Litre H 320mm
 Box of 20



Square Swing Bottle
B14720
 1 Litre H 320mm
 Box of 20



Square Swing Bottle
B14730
 0.25 Litre H 192mm
 Box of 28



Swing Bottle
R91005
 0.75 Litre H 320mm
 Box of 6



Swing Bottle
R90117
 0.5L H 260mm
 Box of 12



Mini Swing Bottle
R90116
 7cl (2.5oz) H 110mm
 Box of 12



Ria Swing Bottle
R91004
 0.75L H 290mm
 Box of 6



Ria Swing Bottle
R91002
 0.25L H 210mm
 Box of 24

Condiment Bottles



Bormioli Rocco ◦ Glassware
Condiments

Textures typical of Italian tradition

Modern shapes are combined with rich glass decoration to emphasise their brilliance. This is a texture reminiscent of majolica, a great Italian tradition dating back to the Renaissance.



Italian Heritage Bottle with Pourer
NEW
49162Q514
 0.25L (8.75oz)
 H 165.6mm (6 1/2") Ø 72.9mm (2 7/8")
 Box of 12



Authentico Oil Bottle
S20104
 30cl (10.5oz)
 H 240mm
 Box of 6



Piri Square Oil Bottle
S20112
 40cl (14oz)
 H 290mm
 Box of 6



Elise Oil & Vinegar
R90013
 28cl (10oz) H 170mm
 Box of 6



Elise Oil & Vinegar
R90014
 17cl (6oz) H 130mm
 Box of 6



Tall Eifel Pepper Pot,
 Stainless Steel Top
C6036P
 H 110mm
 4 Boxes of 12



Tall Eifel Salt Pot,
 Stainless Steel Top
C6036S
 H 110mm
 4 Boxes of 12



Oil & Vinegar
P90248
 15cl (5.25oz) H 135mm
 3 Boxes of 2

Nude ◦ Glassware
Condiments



Nude is built on a firm belief that design is not about embellishment or style, but about the purity in the shape of an object. The Nude Accessories Oil and Vinegar collection boasts elegant and striking design, making any item from the pioneering range a perfect stylish addition to any tabletop.

Vidrios San Miguel ◦ Recycled Glassware
Condiment Bottles



These Oil Bottles are made from 100% recycled glass, showcasing the classic green colourway. All of our recycled products are developed sustainably ensuring environmentally conscious production, without any compromise on quality or style. Ideal for serving oils, vinegars and thin sauces and garnishes to the table.

Utopia ◦ Glassware
Condiments



Square Pepper Pot,
 Stainless Steel Top
C6050
 H 92mm
 4 Boxes of 12



Square Vinegar Bottle,
 Stainless Steel Top
C6020
 H 150mm
 4 Boxes of 12



3cm Square Salt Pot,
 Stainless Steel Top
CDAR-1
 H 50mm
 4 Boxes of 24



Preserving Style Jars
N210965
 3L H 280mm Box of 6
N210964
 2L H 250mm Box of 6
N210963
 1.5L H 216mm Box of 6

Preserving Style Jars
N210962
 1L H 168mm Box of 12
N210961
 0.75L H 144mm Box of 12
N210960
 0.5L H 106mm Box of 12



Terrine
N210982
 350ml H 100mm
 Box of 6



Terrine
N210981
 200ml H 85mm
 Box of 12



Terrine
N210980
 125ml H 70mm
 Box of 12



Mini Terrine Jar
N210984
 7cl (2.5oz) H 85mm
 6 Boxes of 12



Mini Terrine Jars
N210983
 5cl (1.75oz) H 60mm
 8 Boxes of 12



Large Replacement Seals
N580139 Box of 10
 Medium Replacement Seals
N580140 Box of 10
 Small Replacement Seals
N580108 Box of 10



Biscotti Jar Extra Large
NBJ062
6.2L H 294mm
Box of 6



Biscotti Jar Large
NBJIUS
3.8L H 258mm
Box of 6



Biscotti Jar Medium
NBJ019
1.9L H 200mm
Box of 12



Biscotti Jar Small
NBJ009
0.9L H 154mm
Box of 12



Square Biscotti Jar
P98665
1.5L H 190mm
Box of 6



Square Biscotti Jar
P98667
1L H 125mm
Box of 6

The elegance and feel of glass, but virtually unbreakable. The beverageware of choice for some of the world's most prestigious hotels and resorts.

Exquisitely versatile

With Strahl, it's possible to entertain in style, anywhere. Our exquisite products are designed to be chilled in either the refrigerator or freezer, while superior insulation properties keep beverages at optimal drinking temperature for longer.



Design + Contemporary
Water/Soda Goblet
N206103
29.5cl (10.5oz)
H 14.9cm (5 7/8") M 7.6cm (3")
T 7.6cm (3") B 7cm (2 3/4")
Box of 12



Da Vinci Pitcher
N700003
1.5L (52.75oz)
H 23.5cm (9 1/4") M 18.4cm (7 1/4")
T 13.3cm (5 1/4") B 8.6cm (3 3/8")
Box of 3



ASPEN Summit
Aspen Everclear Drinkware

A clear choice in beverageware

Enhance your beverage service with the virtually unbreakable Aspen Everclear Drinkware. Designed to withstand the rigours of foodservice, Aspen is a collection of drinkware made of a superior Polycrystal material that is food grade & ideal for any dining occasion. This range provides excellent translucency and undeniable quality.



Carafe
7030DR007
88.5cl (31.25oz)
H 29.5cm (11 5/8") M 9.8cm (3 7/8")
TØ 4.1cm (1 5/8") BØ 9.8cm (3 7/8")
Box of 12

Black Carafe Cap
7030DR012 Box of 12
Blue Carafe Cap
7032DR012 Box of 12



PC

Jugs & Carafes



Produced using the highest quality polycarbonate Lucent provides a crystal clear finish rivalling glassware, virtually unbreakable this range adds class and safety all at once. If premium polycarbonate is what you need, Lucent has it covered.



Paradise Jug
HD0445
1L (35.25oz)
H 250mm
Box of 6



Gatsby Carafe
HD0200
1.1L
H 255mm
Box of 6



Vision Bottle
HD0301
1L (35oz)
H 270mm
Box of 12

Jugs & Carafes



Atlantic Jug
HD0862
160cl (56.5oz) H 220mm
Box of 4



Pint Jugs
HD0842 3 Pint H 235mm
Box of 6
HD0861-CA 2 Pint LCE@ 2 PT H 205mm
Box of 6
HD0841-LCA
4 Pint LCE@ 2,3,4 PT H 253mm
Box of 6



SAN Jugs
HD0843 4 Pint H 253mm
Box of 6
HD0844 3 Pint H 229mm
Box of 6
HD0857-CA
2 Pint LCE@ 2 PT H 205mm
Box of 6



Handled Carafe
HD0206
1.5L H 280mm
Box of 6



Carafe
CA7090207
1L H 245mm
Box of 12



Carafe
HD0205
1L H 240mm
Box of 6

modern-twist **Placemats & Trivets**



The evolution of a functional linen for tabletop

Modern-twist inspires a better dining experience through design, function, and social responsibility by producing innovative, quality products. Using pure, hand printed silicone, Modern-twist has successfully created a line of placemats, table runners and trivets that are eco-friendly and 100% food safe. Currently used in top hotels, restaurants and airports worldwide, these linens are commercial dishwasher safe, BPA free, and have no memory so they always lay flat. With a look as elegant as cloth and more functional than vinyl, Modern-twist is the perfect addition to your dining room table.

Modern-Twist ◦ Silicone
Placemats & Trivets modern-twist



Linen Silicone Placemat Chocolate
MTPLLNO11216
 30.5 x 40.6cm (12 x 16")
 Box of 12



Linen Silicone Placemat Denim Blue
MTPLLNO21216
 30.5 x 40.6cm (12 x 16")
 Box of 12



Linen Silicone Placemat Black Grey
MTPLLNO71216
 30.5 x 40.6cm (12 x 16")
 Box of 12



Stream Silicone Placemat Silver
MTPLST201216
 30.5 x 40.6cm (12 x 16")
 Box of 12



Twine Silicone Placemat Silver
MTPLTWO41216
 30.5 x 40.6cm (12 x 16")
 Box of 12



Hatch Silicone Placemat Black Grey
MTPLHA071216
 30.5 x 40.6cm (12 x 16")
 Box of 12



Marble Silicone Placemat Grey
MTPLMA071216
 30.5 x 40.6cm (12 x 16")
 Box of 12



Hive Trivet Midnite
MTTVHI00407 17.8cm (7")
 Box of 6



Hive Trivet Cloud
MTTVHI00107 17.8cm (7")
 Box of 6



Hive Trivet Graphite
MTTVHI00307 17.8cm (7")
 Box of 6



Serving Utensils

Even serving utensils should bring style and refinement to a buffet presentation. Steelite-Utopia proudly offers exceptional 18/10 stainless steel collections.



Spoons, ladles, tongs and more

No buffet presentation would be complete without its serving utensils. From a clean and sleek look to a fingerprint-free hammered finished, D.W. Haber offers a variety of 18/10 stainless steel utensils that are suitable for foodservice.

Chicago Serving Utensils



Chicago Pie/Cake Server
DW397CS
24.77cm (9 3/4")
Box of 6



Chicago Large Slotted Spoon
DW397SVSPP
29.21cm (11 1/2")
Box of 6



Chicago Large Solid Spoon
DW397SVSP
29.21cm (11 1/2")
Box of 6



Chicago Medium Spoon
DW3979SVSP
22.22cm (8 3/4")
Box of 6



Chicago Small Spoon
DW3978SVSP
21.59cm (8 1/2")
Box of 6



Chicago Large Fork
DW397SVFK
30.5cm (12")
Box of 6



Chicago Dressing Ladle
DW397LAD1
30.5cm 2.84cl (12" 1oz)
Box of 6



Chicago Soup/Punch Ladle
DWH397LAD4
31.8cm 11.8cl (12 1/2" 4oz)
Box of 6



Chicago Soup Ladle
DW397LAD8
35.56cm 22.73cl (14" 8oz)
Box of 6



Spoon Rest
DW394SR
13.4cm (5 1/4 x 3 3/4 x 3")
Box of 2



Hammered Serving Utensils



Hammered Soup/Punch
Ladle
DW398MLAD4
33cm 11.8cl (13" 4oz)
Box of 6



Hammered Dressing
Ladle
DW398MLAD1
30.5cm 3cl (12" 1oz)
Box of 6



Hammered Pie Lifter
DW398MPL
27.9cm (11")
Box of 6



Hammered Large Serving
Spoon Slotted
DW398MSVSP
33cm (13")
Box of 6



Hammered Large Serving
Spoon Solid
DW398MSVSP
33cm (13")
Box of 6



Hammered Medium
Serving Spoon Solid
DW3981MSVSP
26.7cm (10 1/2")
Box of 6



Serving Tong With
Flat Ends
DW396ST9
22.9cm (9")
Box of 6



Serving Tong
Notched
DW39468
20.3cm (8")
Box of 6



Ice Tong
DW39462
17.8cm (7")
Box of 6



Sugar Tong
DW39461
12.7cm (5")
Box of 6



Hammered
Salad Tong
DW398MST10
25.4cm (10")
Box of 6



Hammered
Serving Tong
DW398MST9
24.1cm (9 1/2")
Box of 6



Hammered
Ice Tong
DW398MST8
20.32cm (8")
Box of 6

Tongs

Serving Utensils



Folio ◦ 18/10 Stainless Steel

Serving Utensils



Bryce

Bryce's stainless steel cutlery features a high quality, 18/10 stainless steel finish and has expanded to a line of serving utensils. With a classic design, create a seamless look from tabletop to buffet with these simply elegant serving pieces.

- 18/10 stainless steel serving utensils
- High quality mirror polished finish
- Modern look, designed for buffet
- Extensive range

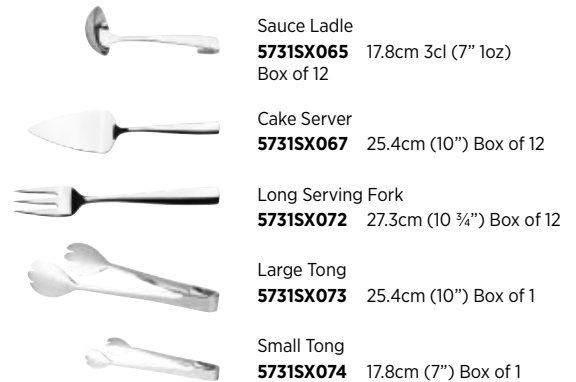

Hepp ◦ 18/10

Serving Utensils



Soft surfaces, curved edges

Well-balanced cutlery transforms any culinary delight into a smooth, sleek experience. Cutlery design should be chosen with harmony in mind, reflecting the statement made by the interior design and décor, the event or occasion, and the food itself.

Carlton

Additions

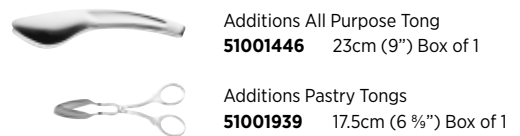

Non-stock. Available on request and subject to an estimated 4 week lead time.



Creations ◦ Melamine

Serving Spoons





Mogogo Buffet Solutions

When versatile functionality meets high design, Mogogo Buffet Solutions can deliver an exceptional line of products which adapt to any venue or occasion. With a vast collection of tables, carts and accessories, the Mogogo collections are designed to create endless configurations from the same structural components. When you think of F&B furniture, think Mogogo - where beautiful, functional products blend seamlessly in any interior, while elevating design standards for your guests.



EXPRESS Y



OUR SHELF



Mogogo

Mogogo Buffet Solutions

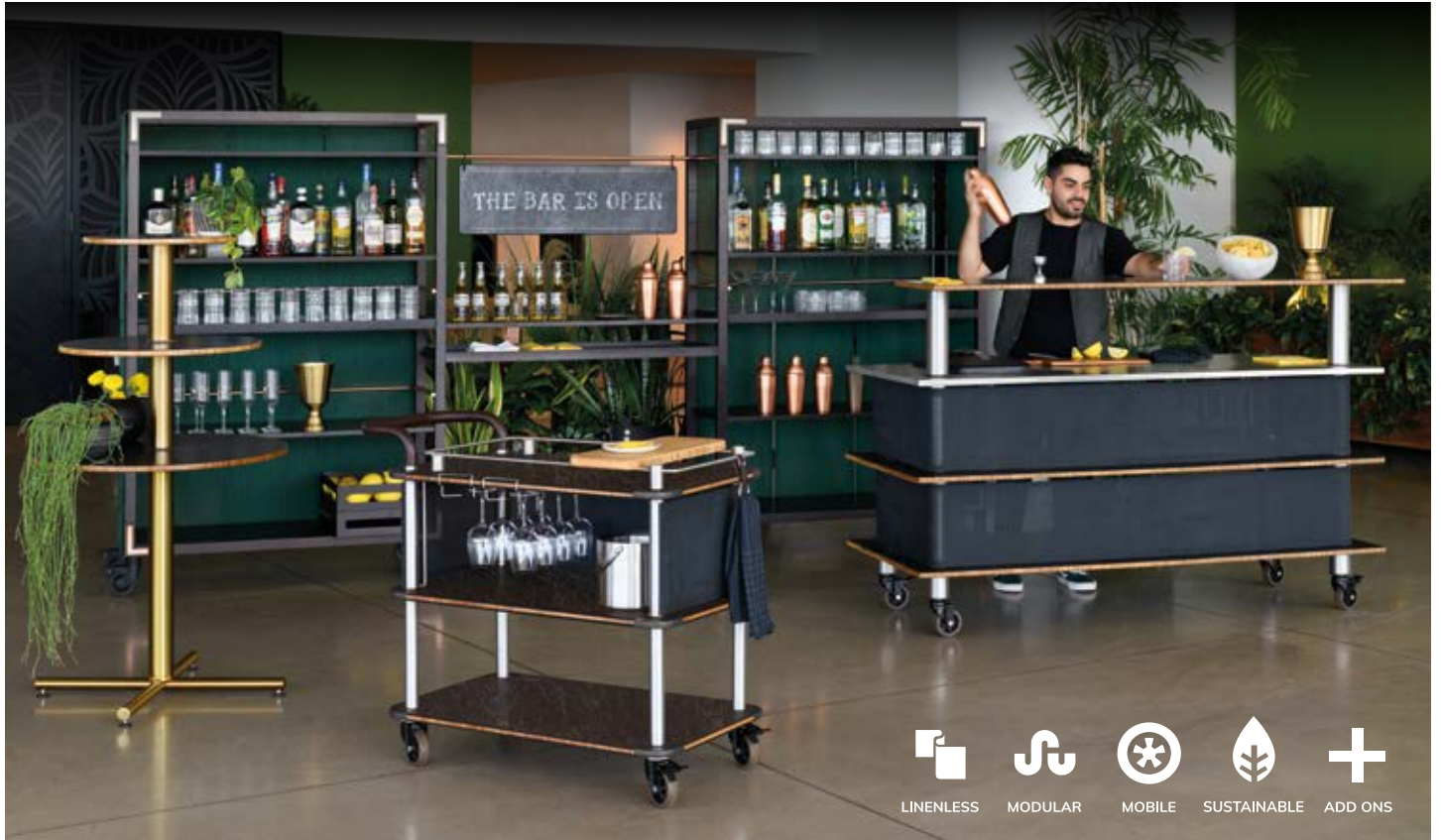

Modular Collection



Canvas Collection



Moby Collection



Roll'n Collection



Oval Collection



Cantine Collection



Mogogo's flagship collection, The Modular System, allows you to use the generic components in various ways to create endless configurations. The Modular System holds the Classic and Creative Ranges, and a large variety of matching add-ons. The Classic Range consists of buffet tables and shelves, functioning as building blocks to the Mogogo System. The Creative Range comes with a curved slim look, offering unique features based on our vast experience in large foodservice operations.



Pro Bar
MGCMC05GSXW
 L180cm W75cm H121cm (L71" W29.5" H47.5")



Back Bar
MGCMC02GSXW
 L180cm W75cm H153.5cm (L71" W29.5" H60.5")



Large Pro Unit
MGCMLA05GSXW
 L180cm W75cm H88.5cm (L71" W29.5" H35")



Classic Plus
MGCMLB13GSXW
 L180cm W75cm H121cm (L71" W29.5" H47.5")

Add-Ons



Classic Canopy Unit
MGCMLB10GSBW
L180cm W75cm
(L71" W29.5")



Classic Arch Station
MGCMLA06GSXF
L180cm W75cm H243cm
(L71" W29.5" H95.5")



Modular Long Blackboard + 2 Hooks
MGSADDSM0201
L120cm H45cm (L47" H18")
Fits Modular Arch or Sign Post



Modular Blackboard 5 Piece Collection
MGSADDSM0301
Fits Modular Arch



Modular Wine Glass Holder
MGSADDSI301
L37.5cm W11cm H6.5cm
(L15" W4.5" H2.5")
Fits Modular Large Wide Bar Shelf

Classic Range



Classic Large Unit
MGCMLX01GSXW
L180cm W75cm H88.5cm
(L71" W29.5" H35")



Classic Corner Unit
MGCMLX04GSXW
L75cm W75cm H88.5cm
(L29.5" W29.5" H35")

Classic Range Shelves



Large Shelf
MGCIAF04GSXX
L180cm W24cm H32cm (L71" W9.5" H12.5")





Large Low Shelf
MGCIAF05GSXX
L180cm W24cm H16.5cm (L71" W9.5" H6.5")



Large Wide Bar Shelf
MGCIAF06GSXX
L120cm W24cm H32cm
(L47" W9.5" H12.5")

TOP

-  Nero Marquina Marble BHP
-  Grey Slate
-  Bengali Mango Wood BHP



SEGMENT

-  Brushed Stainless Steel
-  Brushed Brass

TEXTILE

-  Blue & White Stripes
-  Black

BASE

-  Adjustable Legs
-  Casters

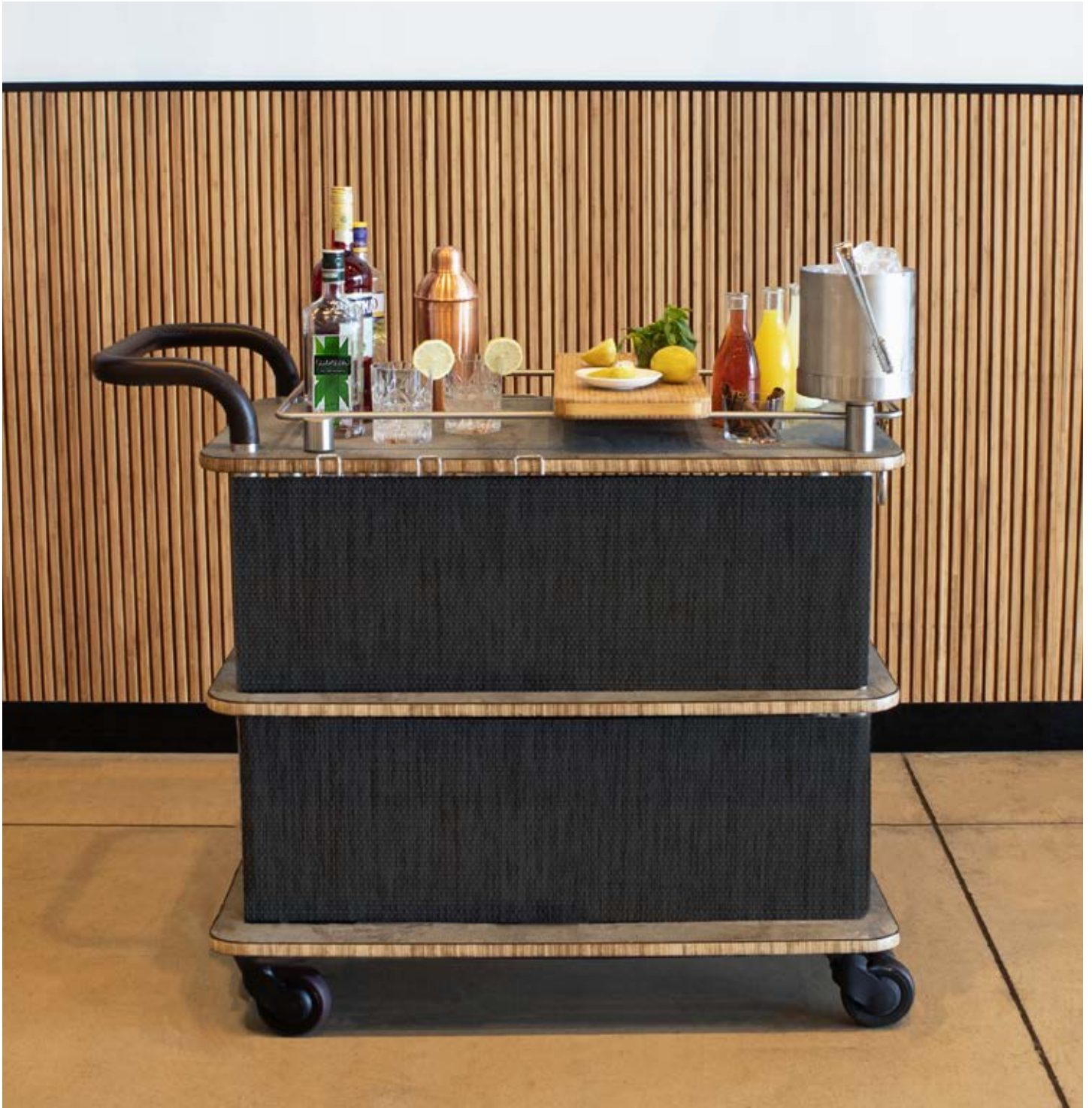

The Roll'n Service Cart collection starts with core elements. It's an elegant and functional cart with heavy-duty silent casters, and a slick genuine leather covered handle to ride with style. It easily drives from back of the house to the front of the house and anywhere you wish. Adding accessories can transform the Roll'n into a variety of usage, cocktail cart, dessert cart and more.



Cheese Plate and Wine Cart **MGCRNX04MSXX**
(shown with optional Charcoal-Black quick cover)



Service Cart
MGCRNX01MSXX
L105cm W53cm H91cm
(L41.5" W21" H36")



Mixology Cart
MGCRNX03GSXX
L105cm W53cm H101.6cm
(L41.5" W21" H40")



Cheese Plate and Wine Cart
MGCRNX04MSXX
L104cm W53cm H102cm
(L41" W21" H36.5/ 40.5")

Service Cart Add-Ons



Border
L80cm W43.2cm H5.1cm (L31.5" W17" H2")
Fits Service Cart
MGSSCMSS0401 Brushed Stainless Steel



Wine Glass Holder
L53cm W11cm H5.5cm (L21" W4" H2")
Holds up to 6 wine glasses
MGSSCMSS0501
Brushed Stainless Steel



Leather Towel Hanger
MGSSCMSL0101



Cutting Board
MGSSCMBM0201
L49cm W20cm H2cm
(L19" W8" H0.7")
Fits Border



Cheese Tray
MGSSCMBM0501
L49cm W30cm H17cm
(L19" W12" H7")
Fits Border



Ice Bucket
MGSSCMSS0601
Ø15.5cm H15.5cm
(Ø6" H6") Fits Border
Brushed Stainless Steel

TOP

- M** Nero Marquina Marble BHP
- G** Grey Slate
- W** Bengali Mango Wood BHP
- C** White Marble Carrara BHP

SEGMENT

- S** Brushed Stainless Steel
- B** Brushed Brass



Bussing Station **MGCCAN14NSXW**

The Canvas Collection is a modular shelving system, acting as a blank page allowing professionals to accomplish their creative vision. It is ideal as a back bar or for showcasing food and beverages and related products. It combines function with uncluttered aesthetics to create this versatile range of shelving, taking into consideration the challenging requirements of foodservice.



Two Shelf Unit
 L 48 ½" W 18" H 73 ½"
N | CASTERS MGCCAN17NSXW
D | CASTERS MGCCAN17DCXW



Three Shelf Unit
 L 48 ½" W 18" H 73 ½"
N | CASTERS MGCCAN14NSXW
D | CASTERS MGCCAN14DCXW



Four Shelf Unit
 L 48 ½" W 18" H 73 ½"
N | CASTERS MGCCAN18NSXW
D | CASTERS MGCCAN18DCXW



Five Shelf Unit
 L 48 ½" W 18" H 73 ½"
N | CASTERS MGCCAN09NSXW
D | CASTERS MGCCAN09DCXW



Dessert Station
 L 48 ½" W 18" H 73 ½"
N | CASTERS MGCCAN15NSXW
D | CASTERS MGCCAN15DCXW



Room Divider
 L 48 ½" W 18" H 73 ½"
N | CASTERS MGCCAN08NSXW
D | CASTERS MGCCAN08DCXW



Angled Shelf Signage Unit
 L 48 ½" W 18" H 73 ½"
N | CASTERS MGCCAN16NSXW
D | CASTERS MGCCAN16DCXW

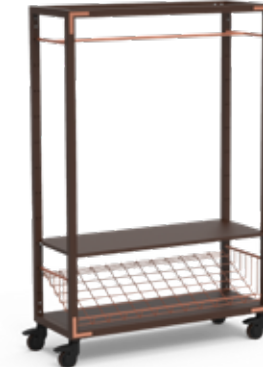

Coat Rack
 L 48 ½" W 18" H 73 ½"
N | CASTERS MGCCAN11NSXW
D | CASTERS MGCCAN11DCXW



Back Bar **MGCCAN05DCXW**
*Shown with optional Jungle Green Screen - **MGSCANPV0101**



Back Bar Unit
L 141 ½" W 18" H 73 ½"
NATURAL | CASTERS **MGCCAN05NSXW**
DARK-LUX | CASTERS **MGCCAN05DCXW**



Center Stage Display
L 84 ½" W 84 ½" H 73 ½"
NATURAL | CASTERS **MGCCAN19NSXW**
DARK-LUX | CASTERS **MGCCAN19DCXW**



Center Stage Display **MGCCAN19NSXW**

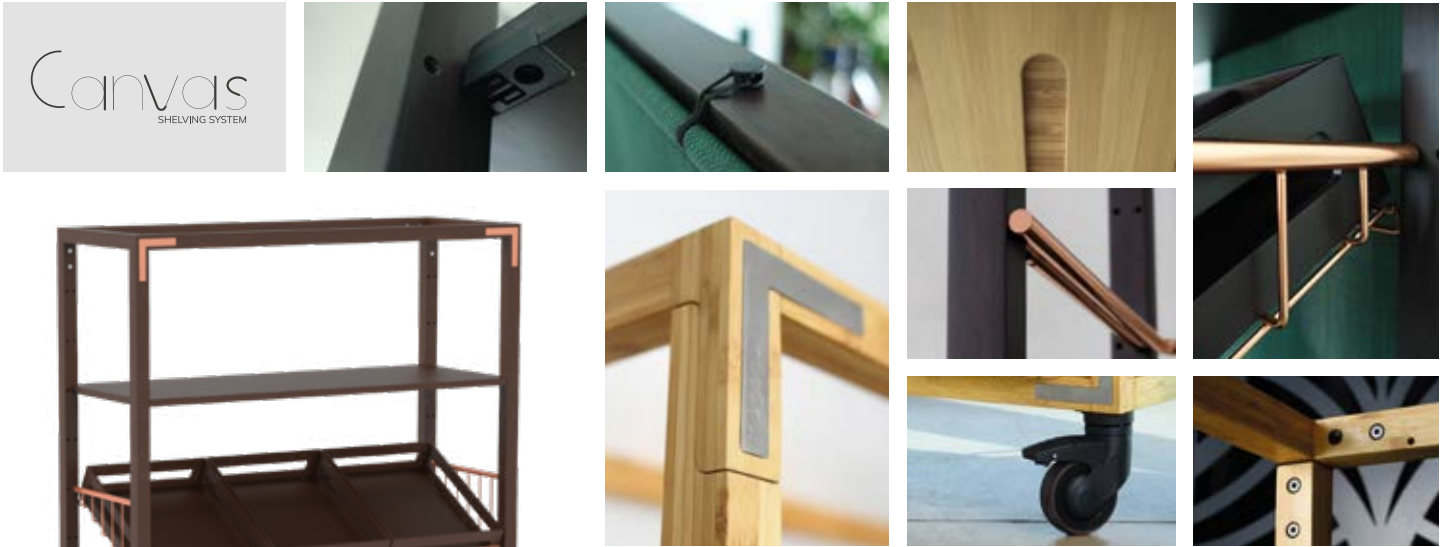

Express your shelf

The Canvas Collection is an innovative shelving system for the hospitality sector, acting as a blank page allowing professionals to accomplish their creative vision. The collection is ideal as a back bar or for showcasing food and beverages and related products. It combines function with uncluttered aesthetics to create this versatile range of shelving, taking into consideration the unique and challenging requirements of foodservice.

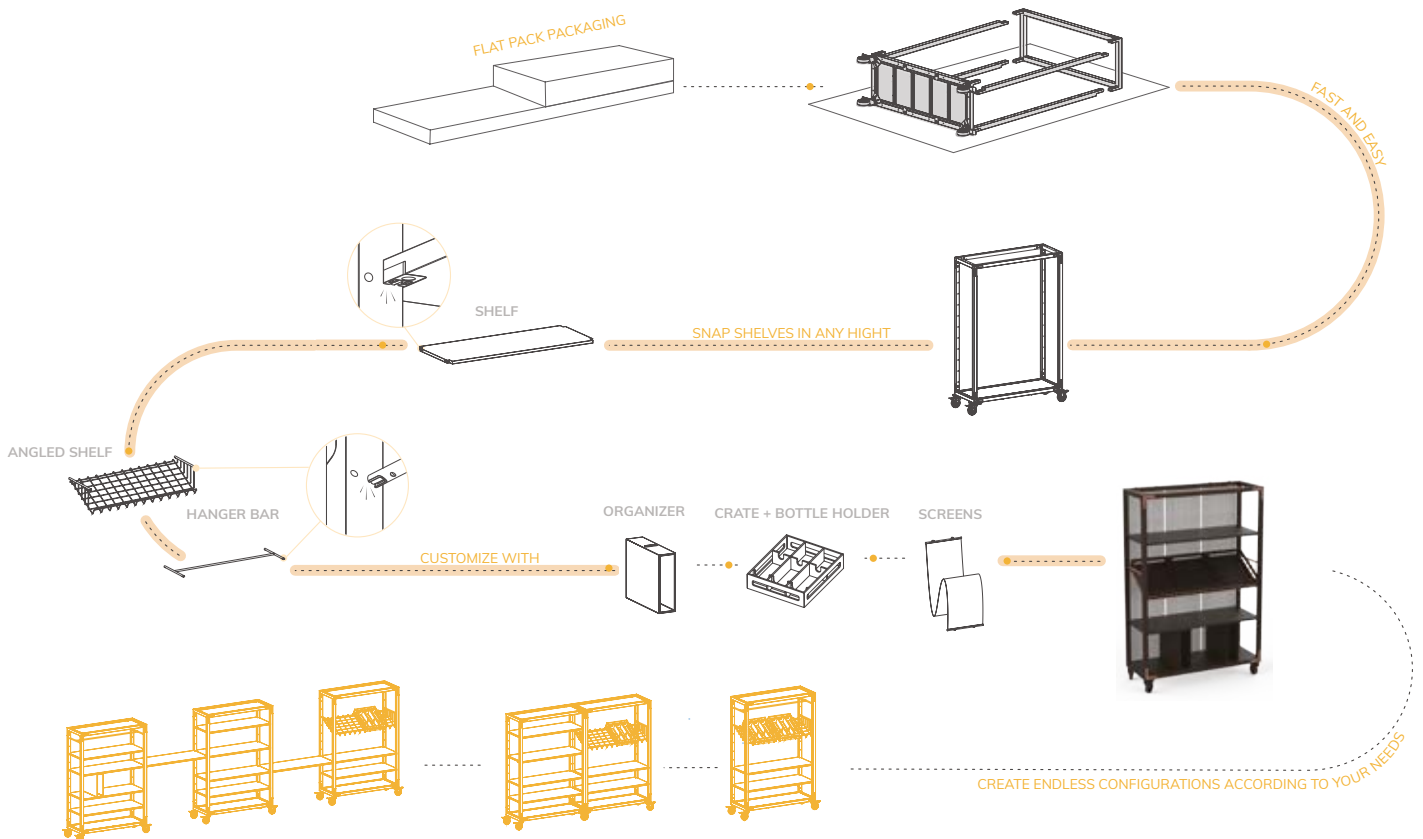

Build your own base and Fixtures - Natural

Natural horizontal bamboo | sandblasted stainless steel



Empty Unit With Casters
MGCCAN13NSXW
L 48 1/2" W 18" H 73 1/2"



Angled Shelf
MGSCANSS0301
Can fit up to 3 crates



Crate
MGSCANBM0301
With or without bottle holder

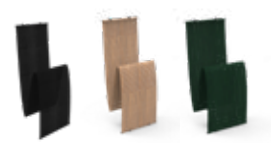

Screens
Charcoal Black | **MGSCANPV0101**
Golden Brown | **MGSCANPV0201**
Jungle Green | **MGSCANGP0101**
Set of 5



Top Frame Shelf
MGSCANBM0601



Shelf Retaining Bar
MGSCANSS0401



Bottle Holder
MGSCANBM0401
Fits crate



Corner Shelf Connectors
MGSCANBM1101
To connect two units in 90° | Set of 2



Shelf
MGSCANBM0201



Hanger Bar
MGSCANSS0101



Organizer
MGSCANBM0501



Unit Connectors
MGSCANBM0901
To connect two units | Set of 2



Shelf with Border
MGSCANBM0701



Top Frame Hanger Bar
MGSCANSS0201
For top unit



Sign
MGSCANSM0901
Comes with 2 hooks



Bumpers
MGSCANSM0801
Set of 4



Empty Unit with Casters
MGCCAN13DCXW
L 48 1/2" W 18" H 73 1/2"

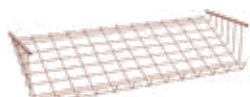

Angled Shelf
MGSCANSC0301
Can fit up to 3 crates



Crate
MGSCANDB0301
With or without bottle holder



Screens
Charcoal Black | **MGSCANPV0101**
Golden Brown | **MGSCANPV0201**
Jungle Green | **MGSCANGP0101**
Set of 5



Top Frame Shelf
MGSCANDB0601



Shelf Retaining Bar
MGSCANSC0401



Bottle Holder
MGSCANDB0301
Fits Crate



Corner Shelf Connectors
MGSCANDB1101
To connect two units in 90° | set of 2



Shelf
MGSCANDB0201



Hanger Bar
MGSCANSC0101



Organizer
MGSCANDB0501



Unit Connectors
MGSCANDB0901
To connect two units | set of 2



Shelf With Border
MGSCANDB0701



Top Frame Hanger Bar
MGSCANSC0201
For top unit



Sign
MGSCANSM0901
Comes with 2 hooks



Bumpers
MGSCANSM0801
Set of 4

Build your own base and Fixtures - Dark-Lux

Dark brown stained bamboo | Sandblasted Copper plated stainless steel



The cooling centrepiece

Every service needs a showstopper - but what if it was functional too? Moby's double-wall structure keeps drinks chilled and surfaces dry, while its contemporary design makes it stand out. Fill it with ice for a bottle display or fit it with a stainless steel bowl to serve delicious punch or fresh fruit. Whether you choose the countertop or freestanding unit, Moby steals the spotlight every time. Compact in size but big on impact, the Moby Countertop Unit brings a sculptural presence to any setting. Tall, sleek, and remarkable, the Moby Freestanding Unit is designed to stand out like a sculpture.



Freestanding Unit
 Forest Green
MGSMOBF00201 ●
 Ø 52 H 89cm
 (Ø 20 ¾ H 35")
 Box of 1

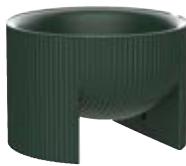

Countertop Unit
 Forest Green
MGSMOBF00101 ●
 Ø 52 H 35cm
 (Ø 20 ¾ H 13 ¾")
 Box of 1



Freestanding Unit
 Butter Cream
MGSMOBB0201 ●
 Ø 52 H 89cm
 (Ø 20 ¾ H 35")
 Box of 1



Countertop Unit
 Butter Cream
MGSMOBB0101 ●
 Ø 52 H 35cm
 (Ø 20 ¾ H 13 ¾")
 Box of 1



Freestanding Unit
 Maroon
MGSMOBMA0201 ●
 Ø 52 H 89cm
 (Ø 20 ¾ H 35")
 Box of 1

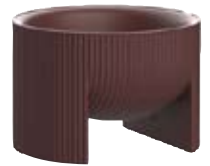

Countertop Unit
 Maroon
MGSMOBMA0101 ●
 Ø 52 H 35cm
 (Ø 20 ¾ H 13 ¾")
 Box of 1



Stainless Steel Bowl
 Sold Separately
MGSMOBSS0101 ●
 Box of 1



Fresh, fun, and versatile

The Oval station is made to shine indoors or out. Its sculptural form comes in modern colourways and can be paired with an umbrella for extra charm and shade. From a lively gelato stand to an eye-catching mixology counter, Oval can adapt to any setting. Used with its core base tabletop, it becomes anything you need it to be with durability, functionality, and a sprinkle of vacation.



Oval Base Cart Vanilla Top
 L 234 W 229 H 249cm
 (L 92 W 90 H 98")
MGCOVC03VXCC ●
 Cream Cover w/Cream Umbrella
MGCOVC03VXBB ●
 Black Cover w/Black Umbrella



Oval Cocktail Cart Vanilla Top
 L 234 W 229 H 249cm
 (L 92 W 90 H 98")
MGCOVC02VXCC ●
 Cream Cover w/Cream Umbrella
MGCOVC02VXBB ●
 Black Cover w/Black Umbrella



Oval Gelato Cart Vanilla Top w/ Umbrella
 L 234 W 229 H 249cm
 (L 92 W 90 H 98")
MGCOVC01VXCC ●
 Cream Cover w/Cream Umbrella
MGCOVC01VXBB ●
 Black Cover w/Black Umbrella



Oval Ice Bin
 L 151 W 64 H 90cm
 (L 59 ½ W 25 ¼ H 35 ½")
MGCOVE01BXXB ●
 Black Ice Bin w/ Black Cover



Oval Base Cart Vanilla Top
 L 151 W 64 H 90cm
 (L 59 ½ W 25 ¼ H 35 ½")
MGCOVC03VXXC ●
 Cream Cover
MGCOVC03VXXB ●
 Black Cover



Oval Cocktail Cart Vanilla Top
 L 151 W 64 H 90cm
 (L 59 ½ W 25 ¼ H 35 ½")
MGCOVC02VXXC ●
 Cream Cover
MGCOVC02VXXB ●
 Black Cover



Oval Gelato Cart Vanilla Top
 L 151 W 64 H 90cm
 (L 59 ½ W 25 ¼ H 35 ½")
MGCOVC01VXXC ●
 Cream Cover
MGCOVC01VXXB ●
 Black Cover



Oval Ice Bin
 L 151 W 64 H 90cm
 (L 59 ½ W 25 ¼ H 35 ½")
MGCOVE01CXXC ●
 White Ice Bin w/ Cream Cover

Oval Components



Oval Base Cart
 BHP Table Top Vanilla
MGSOVCHV0301 ●
 Box of 1



Oval Cocktail Cart
 BHP Table Top Vanilla
MGSOVCHV0201 ●
 Box of 1



Oval Gelato Cart
 BHP Table Top Vanilla
MGSOVCHV0101 ●
 Box of 1



Large Ice Bin
MGSADDPL0901 ●
 Black
 Box of 1



Modular Ice Bin Side
 Tray
MGSTRYBP0101 ●
 Box of 2



Mogogo's cover version of the archetype iconic market cart

These carts have existed for centuries for goods transportation and for merchandise displaying at markets around the world. Mogogo revives this concept, by updating the design and materials while respecting the past. Bent bamboo beams are the core of the Cantine Cart, giving the construction strength in a streamlined style. The lightweight bamboo structure is durable, and with additional decorative metal elements it creates a fine tension between a traditional look and advanced design.



Cantine Cart with Shelves
Dark with Black Wheels
MGCCNT01DSXX
L204.5cm W76.0cm H188.0cm (L80½" W30" H71")

- Components
- MGSCNTSM0401** Body and Frame - Dark Qty: 1
 - MGSCNTMT0201** Shelf Frame Qty: 1
 - MGSCNTDB0501** Shelf - Dark Qty: 2
 - MGSCNTSM0201** Wheels - Black Qty: 1



Cantine Cart with Shelves & Crates
Dark with Black Wheels
MGCCNT02DSXX
L204.5cm W76.0cm H188.0cm (L80½" W30" H71")

- Components
- MGSCNTSM0401** Body and Frame - Dark Qty: 1
 - MGSCNTMT0201** Shelf Frame Qty: 1
 - MGSCNTDB0501** Shelf - Dark Qty: 2
 - MGSCNTDB0401** Crate Support Shelf - Dark Qty: 1
 - MGSCNTSM0201** Wheels - Black Qty: 1
 - MGSCNTDB0601** Crate Dark Bamboo Qty: 6



Cantine Cart with Shelf & Crates & Sign
Dark with Black Wheels
MGCCNT05DSXX
L204.5cm W76.0cm H188.0cm (L80½" W30" H71")

- Components
- MGSCNTSM0401** Body and Frame - Dark Qty: 1
 - MGSCNTMT0201** Shelf Frame Qty: 1
 - MGSCNTDB0501** Shelf - Dark Qty: 1
 - MGSCNTDB0401** Crate Support Shelf - Dark Qty: 1
 - MGSCNTDB0601** Crate Dark Bamboo Qty: 6
 - MGSCNTSM0501** Sign Qty: 1
 - MGSCNTSM0201** Wheels - Black Qty: 1



Cantine Cart (Cart Only)
Dark with Black Wheels
MGCCNT04DSXX
L204.5cm W76.0cm H92.0cm (L80½" W30" H36")

- Components
- MGSCNTSM0401** Body and Frame Dark Qty: 1
 - MGSCNTSM0201** Wheels - Black Qty: 1





Standalone shield to fit any flat surface

The perfect addition to any buffet or station, Mogogo V-Shield Breath Guards can be used on most existing flat surfaces of any length, with features to turn corners and shield the ends. The brushed stainless steel black legs are equipped with magnets, notches, and anti-slip pads for additional stability and a clean gap-free appearance, while the acrylic shields are available in several sizes to accommodate your needs.

1/4" | 6mm ACRYLIC PANEL

BLACK ANODIZED ALUMINIUM



MAGNETS FOR EASY AND SECURE ATTACHMENT

1/4" | 6mm BRUSHED STAINLESS STEEL

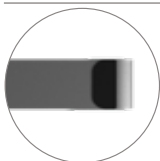

ANTI-SLIP PADS

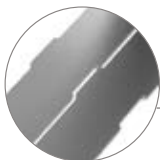

ALIGNMENT NOTCHES



END PANELS

The V-Shield end panels are aimed to complete any guard configuration and provide a safe environment for both the guest and server.



CORNER PANELS

The V-shield corner panels are designed to create configurations that require tight corners or a gentle radius, while maintaining a tight seal.





Wide V-Shield
MGCDV001CSAC
L89.0cm H90cm (L35" H35.5")



Wide V-Shield w/Opening
MGCDV001CSAS
L89.0cm H90cm w/15cm Gap
(L35" H35.5" w/6" Gap)



Narrow V-Shield
MGCDV002CSAC
L50cm H90cm (L20" H35.5")



Narrow V-Shield w/Opening
MGCDV002CSAS
L50cm H90cm w/15cm Gap
(L20" H35.5" w/6" Gap)



Double Wide V-Shield
MGCDV003CSAC
L178cm H90cm (L70" H35.5")



Double Wide V-Shield w/Opening
MGCDV003CSAS
L178cm H90cm w/15cm Gap (L70" H35.5" w/6" Gap)



Double Wide V-Shield w/Opening and End Panels
MGCDV004CSAS
L178cm H90cm Ø56.6cm w/15cm Gap
(L70" H35.5" Ø22.25" w/6" Gap)



Extra Wide V-Shield
MGCDV005CSAC
L228cm H90cm (L90" H35.5")



Extra Wide V-Shield w/Opening
MGCDV005CSAS
L228cm H90cm w/15cm Gap (L90" H35.5" w/6" Gap)



Extra Wide V-Shield w/Opening and End Panels
MGCDV006CSAS
L228cm H90cm Ø56.6cm w/15cm Gap
(L90" H35.5" Ø22.25" w/6" Gap)

Replacement Parts

- MGSVSDPG0101** Wide Acrylic Panel For V-Shield Breath Guard
L89cm H91cm (L35" H36")
- MGSVSDPG0201** Wide Acrylic Panel w/Opening For V-Shield Breath Guard
L89cm H75cm (L35" H29.5")
- MGSVSDPG0301** Narrow Acrylic Panel For V-Shield Breath Guard
L50cm H91cm (L20" H36")

- MGSVSDPG0401** Narrow Acrylic Panel w/ Opening For V-Shield Breath Guard
L50cm H75cm (L20" H29.5")
- MGSVSDSM0101** Set of Legs Brushed Stainless Steel Black Anodized Finish
L26cm H62cm (L10" H24")
- MGSVSDSM0201** Set of Acrylic Corner Panels For V-Shield Breath Guard
L26.2cm H90cm (L10.5" H35.5")
- MGSVSDSM0301** Set of Acrylic End Panels For V-Shield Breath Guard
L56.5cm H90cm (L22.25" H35.5")



Customise your modular stations by choosing from the different colours and finishes available.













Simply choose your preferred design combination by inserting the corresponding letter to its designated space as demonstrated below.

PREFIX **MG**

+

ITEM CODE **C#####**

+

TOP	SEGMENT	TEXTILE	BASE
			
			
M Nero Marquina Marble BHP	S Brushed Stainless Steel	W Blue & White Stripes	F Adjustable Legs
			
G Grey Slate BHP	B Brushed Brass	B Black	W Casters
			
W Bengali Mango Wood BHP			

Example:
MGCMLB10GBWF



A modern foodservice furniture brand born from a passion for style and gastronomy. A perfect balance of luxury and function.



Quick Cover Reference Guide



Easily cover up parts of your buffet stations with our original quick covers, both durable and easy to clean

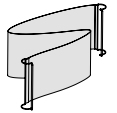

Fits Unit	Amount	Golden-Brown	Silver-Grey	Charcoal-Black	Jungle-Green
-----------	--------	--------------	-------------	----------------	--------------



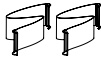

MODULAR COLLECTION

 Classic Large Unit		MGSQCOPV0301	MGSQCOPV0401	MGSQCOPV1601	MGSQCOGP0201
 Classic Medium Unit		MGSQCOPV0501	MGSQCOPV0601	MGSQCOPV1701	MGSQCOGP0301
 Classic Small Unit		MGSQCOPV0701	MGSQCOPV0801	MGSQCOPV1801	MGSQCOGP0401
 Classic Corner Unit		MGSQCOPV2401	MGSQCOPV2501	MGSQCOPV2601	MGSQCOGP1101
 Creative Curved Unit		MGSQCOPV0901	MGSQCOPV1001	MGSQCOPV1901	MGSQCOGP0501
 Creative Extension Unit		MGSQCOPV1101	MGSQCOPV1201	MGSQCOPV2001	MGSQCOGP0601
 Classic Large Shelf		MGSQCOPV0101	MGSQCOPV0201	MGSQCOPV1501	MGSQCOGP0101

Modular 360° Quick Covers

 Classic Large Unit		MGSQCOPV3401	MGSQCOPV3301	MGSQCOPV3201	MGSQCOGP0801
--	---	--------------	--------------	--------------	--------------

Roll'n Service Cart Quick Covers

 Quick Cover Service Cart		MGSQCOPV1301	MGSQCOPV1401	MGSQCOPV2101	MGSQCOGP0701
 Storage Quick Cover Service Cart		MGSQCOPV2902	MGSQCOPV3602	MGSQCOPV3702	MGSQCOGP1202



Foodservice Equipment

Steelite-Utopia's expertly curated Foodservice Equipment collection, is perfectly designed to complement our renowned Tableware and Glassware ranges. From versatile Gastronorms and practical Kitchen Accessories to durable Waste Containers and stylish Service Trays, every piece is crafted to deliver seamless service and exceptional presentation.



Stainless Steel Food Pans



Truly versatile, these food pans are suitable for cooking, food transportation, preparation and storage, heating and chilling.

Stainless Steel Pan GN ¼

F70024	2cm Deep Box of 6
F70025	4cm Deep Box of 6
F70026	6.5cm Deep Box of 6
F70027	10cm Deep Box of 6
F70028	15cm Deep Box of 6
Stainless Steel Handled Lid GN ¼	
F70035	Box of 6

Stainless Steel Pan GN ½

F70015	2cm Deep Box of 6
F70016	4cm Deep Box of 6
F70017	6.5cm Deep Box of 6
F70018	10cm Deep Box of 6
F70019	15cm Deep Box of 6
F70020	20cm Deep Box of 6
Stainless Steel Handled Lid GN ½	
F70033	Box of 6

Stainless Steel Pan GN ¾

F70011	6.5cm Deep Box of 6
F70012	10cm Deep Box of 6
F70013	15cm Deep Box of 6
F70014	20cm Deep Box of 6
Stainless Steel Handled Lid GN ¾	
F70032	Box of 6

Stainless Steel Pan GN ¼

F70007	6.5cm Deep Box of 6
F70008	10cm Deep Box of 6
F70009	15cm Deep Box of 6
F70010	20cm Deep Box of 6
Stainless Steel Handled Lid GN ¼	
F70031	Box of 6

Stainless Steel Pan GN ½

F70003	6.5cm Deep Box of 6
F70004	10cm Deep Box of 6
F70005	15cm Deep Box of 6
F70006	20cm Deep Box of 6
Stainless Steel Handled Lid GN ½	
F70030	Box of 6

Stainless Steel Pan GN ¾

F70000	6.5cm Deep Box of 6
F70001	10cm Deep Box of 6
F70002	15cm Deep Box of 6
Stainless Steel Handled Lid GN ¾	
F70029	Box of 6

Stainless Steel Pan GN ¾

F70023	10cm Deep Box of 6
---------------	--------------------

Stainless Steel Perforated Pan GN ¼

F70036	2cm Deep Box of 6
F70037	4cm Deep Box of 6
F70038	6.5cm Deep Box of 6
F70039	10cm Deep Box of 6
F70040	15cm Deep Box of 6



Polycarbonate Food Pans

Polycarbonate pans, lids, and drain grates are designed for low to mid temperature storage applications.

- High impact Polycarbonate
- Easy clean smooth interior
- Resistant to staining and chipping.



¼ GN Pan

CA10200B07	6.5cm Deep Box of 6
CA10201B07	10cm Deep Box of 6
¼ GN Universal Handled Lid	
CA10210U07	Box of 6

½ GN Pan

CA10222B07	15cm Deep Box of 6
CA10223B07	20cm Deep Box of 6
¼ GN Universal Handled Lid	
CA10290U07	Box of 12

½ GN Pan

CA3066107	10cm Deep Box of 6
CA3066207	15cm Deep Box of 6
½ GN Universal Handled Lid	
CA10270U07	Box of 6

¾ GN Pan

CA3068507	15cm Deep Box of 6
¾ GN Universal Handled Lid	
CA10310U07	Box of 12
CA3068307	6.5cm Deep Box of 6

¾ GN Pan

CA3068607	6.5cm Deep Box of 6
CA3068707	10cm Deep Box of 12



Black Non-Slip Trays



Deliver drinks directly to your customer without incident with these high quality non-slip trays. Tough plastic trays with a non-slip rubber layer which has been bonded to the surface which helps to reduce accidental damage. Not recommended for use in dishwashers.

Oval Black Non Slip Trays

JMP924 68.5 x 56.5cm (27 x 22")

Box of 6

Round Black Non Slip Trays

JMP921 40.5cm (16")

Box of 12

JMP923 35.5cm (14")

Box of 12

JMP922 28cm (11")

Box of 12

Fast Food Trays



Economical and lightweight polypropylene trays in a range of colours. The trays have an anti-slip surface and stacking lugs to accelerate drying.

Black Café Fast Food Trays

CACT101403 36 x 26cm (14 x 10")

Box of 24

CACT121603 43 x 30cm (16 x 12")

Box of 24

CACT141803 46 x 36cm (18 x 14")

Box of 12

Blue Café Fast Food Trays

CACT101414 36 x 26cm (14 x 10")

Box of 24

CACT121614 43 x 30cm (16 x 12")

Box of 24

Waste Containers



Trimline bins are designed for narrow spaces and areas where space is at a premium and feature corner tabs to keep bags in place.

Trimline Grey Waste Container

CA34202323 87L

Box of 1

Trimline Grey Waste Container

CA34201523 60L

Box of 1

Fusion Buffet System

Teak Wood Finish

- Not dishwasher safe.
- Use a soft cloth with water to wipe down surface.
- Do not use any chemical products or abrasives.

Teflon and Stainless-Steel Coating

- Dishwasher safe.
- Clean in dishwasher or use a soft cloth sprinkled with a few drops of dishwashing liquid to wipe Teflon surface cleans. Wipe off soapy residue with a damp cloth.
- A stainless-steel cleaner can be used to polish stainless steel risers.

Tile Inserts - Resin, Teak Wood, and Glass

- All dishwasher safe, except for wood tiles. Never put wood in the dishwasher.
- Teak wood - wipe down with a soft damp cloth and few drops of dishwashing liquid. Wipe off residue with a soft cloth.
- Resin and Glass - dishwasher safe.

Chafers & Marmites:

Stainless Steel

- Exterior frame and food pans are dishwasher safe.
- The chafing dish frame and cover may be cleaned with warm, soapy water or in the dishwasher.
- The induction water pan should be hand washed.
- Occasionally the frame may need polishing. Use a stainless-steel cleaner or glass cleaner without ammonia.
- Over time the water pan may accumulate water deposit. This can be removed with a de-liming solution.

Homestyle Cast Iron Chafers –

Teflon Coating

- Dishwasher safe.
- Rinse with warm water and use a soft nylon brush to remove stuck-on bits before loading in the dishwasher.

Food Pans

- Dishwasher safe.

Induction Ranges

- Not dishwasher safe.
- Avoid abrasive cleaners and scouring pads.
- Allow the surface to cool before cleaning.
- Wipe clean using a soft cloth and mild dishwashing liquid soap. Wipe off soap residue with a damp cloth.

Heater Stands:

- Dishwasher safe.
- For aluminium hot plates and grills, a degreaser can be used to remove black stains from fuel use.

Induction Range:

- Avoid abrasive cleaners and scouring pads.
- Allow the surface to cool before cleaning.
- Wipe clean using a soft cloth and mild dishwashing liquid.
- Wipe soap residue with a soft damp cloth.

Heat Lamps:

- Not dishwasher safe.
- Make sure power is switched off before servicing unit.
- Unplug the unit from the power source.
- Allow lamps to cool before cleaning the unit or replacing bulbs.
- Remove bulbs and use a mild detergent such as dishwashing liquid with a soft sponge or cloth to wipe down.
- Dry with a soft cloth. Completely dry before the next use.
- Do not immerse the unit in water and never use abrasive or scouring powders.

Carving Boards:

Wood Boards

- Not dishwasher safe.
- Hand wash the board immediately after use with water and dishwashing soap.
- Pat the board dry with a paper towel or dishtowel immediately after cleaning.
- To maintain and extend the board life, season weekly, bi-weekly or monthly by wiping food-grade mineral oil over your dry board's exterior. Let the oil sit for a few hours. Wipe off excess oil with a dry cloth.
- Never use olive or vegetable oil to season a carving board.

White Poly Board

- Dishwasher safe

Black Granite

- Dishwasher safe

Beverage Urns, Milk & Cereal Dispensers:

Juice & Beverage Urn, Milk Dispenser

- Components are not dishwasher safe.
- Do not use abrasive products.

Daily:

- Remove nozzles and diffusers and soak them in warm, soapy water.
- Use hot water and mild soap to clean inside of dispenser and then rinse thoroughly.
- Clean outside with a warm wet cloth.
- Clean spigot by removing rubber seat cup and clean by brushing inside of faucet.

Regular Basis:

- Flush and clean water lines.

Coffee Urn

Cleaning

- Always rinse urn immediately after each use.
- Add a small quantity of hot water, brush insides, and rinse with hot water.
- Never immerse base of Urn in water.
- Clean spigot by removing rubber seat cup and clean by brushing inside of faucet.
- Tip - Use rubber gloves to ensure the faucet is tight when you screw it back on to prevent leakage.

De-Staining

- Put 1 cup baking soda into your stainless-steel coffee pot and fill with warm water.
- Use a dish brush to scrub inside of the pot with baking soda solution in it.
- Pour solution out and thoroughly rinse inside with hot water until it runs clean.

Cereal Dispenser

- Disassemble all parts and clean interior with warm soapy water, rinse thoroughly.
- All parts should be completely dry before reassembling.

Stainless Steel Display Items

(Cold Buffet & Wine):

- Dishwasher safe.
- Do not use steel pads, wire brushes or scrapers. Do not use powders, or cleaners that contain chlorides, bromides or iodides.
- Always rinse thoroughly with fresh water after every cleaning operation.
- Wipe unit dry with a soft cloth to remove water.
- Always rub in the direction of the steel grain for maximum effectiveness to avoid marring the surface.
- For smears or fingerprints, wipe with a clean slightly damp cloth. If that doesn't work, use a stainless-steel commercial cleaner.

Kenny Mack Resin

- Dishwasher and food safe.
- Product doesn't stain however on darker colours a white film may develop over time due to drying agents. If this occurs, wiping the surface with any type of oil will bring back the original colour.
- If any chipping occurs, use light sandpaper or a rough sponge to buff and smooth down the chip.



Creative Tableware includes an array of products all of which require different care to ensure you keep them at their best. See below for information on how to look after you Creative Table products.

Estrella Traditional Terracotta:

- Suitable for traditional ovens, hobs, microwaves & freezers.
- Terracotta is naturally fragile and should be handled with care.
- Terracotta is naturally porous, soaking in water should be avoided.
- Terracotta is suitable as oven to tableware.

Fuji: (as above)

- However, with increased strength and durability.

Copper Presentation Serveware:

- Please be aware copper will naturally oxidise over time.
- To maintain an optimum finish, hand washing is recommended.
- Using metal scourers or abrasive cleaners will affect the finish of your copper serve ware, to avoid this, wash in hot water straight after use with a soft cleaning sponge.

Wire Baskets & Presentation Papers:

- Not suitable for cooking and should be used as presentation only.
- Suitable for dishwashers.
- Not suitable for ovens or microwaves.
- Presentation papers are 100% biodegradable and can be discarded in food waste.

Slate/Granite:

- Being natural stones – our slate and granite items may vary slightly in size and texture.
- The characteristics of slate are that the edges can naturally chip and create sharp points – care must be taken when handling these items.
- To clean wipe down with a damp cloth and mild detergent.
- For Slate – any scratches can be treated with natural oil and this should be followed from time to time to keep the product looking its best.



Cast Iron:

- Cast Iron is ideal for use in the oven and on stoves and withstands temperatures up to 260°C.
- Always use heat protective wear when handling the products – handles will become extremely hot.
- Never place hot items directly onto unprotected surfaces – it is recommended to use the Acacia Wooden Boards that are available with all Utopia Cast Iron pieces.
- For care of the Cast Iron Wooden Boards – follow the Acacia Wooden Board/Tray' care advice.
- Always use Plastic/Wooden utensils – metal may damage the surface of the enamel.
- Abrasive scourers may also damage the enamel surface – to remove tough residue soak in hot soapy water.
- Not recommended for dishwashers
- Ensure completely dry before storing or stacking as items left wet may be prone to rusting.

Bento Boxes:

- Not suitable for dishwashers, hand wash only.
- Not suitable for oven or microwave use.
- Abrasive scourers may damage the surface of the item – use a soft sponge and soak in hot soapy water for tougher residue.

Natural Woods:

- Store away from direct heat sources and direct sunlight.
- Hand wash in warm soapy water.
- Do not soak in water.
- Dry immediately.
- Not dishwasher safe.
- Bamboo drink paddles are suitable for glass washers – always follow the recommended dish washing procedures outlined by the manufacturer and use the correct dose application of detergent.
- Sourced from a sustainable wood source.
- Darwin, Acacia, Olive and Fir Wood will vary significantly in size and shape as these are natural cuts of wood.
- Restore Natural Woods with a wiping of olive oil.

**Enamel:**

- Oven proof and Dishwasher safe.
- For best results, after use soak in warm water, then wash gently with a liquid detergent.
- Do not use abrasive cleaning pads or powders.
- Items will chip if handled roughly.

Trays:

Plastic Black Non-Slip Trays:

- Always ensure trays are stacked on flat surfaces to eliminate accidental damage.
- Not suitable for dishwashers – wipe down with a clean damp cloth after each use.
- Do not leave submerged in water.
- Do not stack whilst damp.
- Do not overload trays, may cause accidental damage or injury.

Fast Food Trays:

- Always ensure trays are stacked on flat surfaces to eliminate accidental damage.
- Fast Food Trays are suitable for dishwashers – always follow the recommended dish washing procedures outlined by the manufacturer and use the correct dose application of detergent.
- Fast Food Trays have stacking lugs to accelerate drying and can therefore be stacked straight after washing without prior drying.
- Surface can become slippery when wet, extra caution needed.
- Always stack separately to other crockery in the dishwasher to ensure items do not damage each other in the cycle.

Creations Wood:

To best maintain product finish and condition:

- Do not place near an open flame or grille.
- Products should be stored in a dry location at room temperature.
- Do not store near heat sources or in humid places.
- This product should not be used in the dishwasher, oven, microwave or freezer.
- Clean with a soft damp cloth or wash with hot soapy water, do not soak in water or wash with harsh detergents.
- Sanitise using an antibacterial spray or food safe liquid sanitiser.
- Dry promptly after cleaning, ensure products are dry before stacking.
- In order to maintain product finish and condition, apply a light coat of mineral oil with a clean dry cloth, to prevent wood from drying and cracking.
- Do not leave in direct sunlight for long periods of time.



Modern Twist:

- All products are free of by products and fillers.
- No BPA, PVC, lead, latex or phthalates.
- Dishwasher safe on the top rack.
- Keep away from sharp objects.
- To prevent staining rinse or wipe with a damp cloth after each use.
- Do not use chemical sprays.

Placemats

- Hand printed pure silicone, non-porous, food grade and plastic-free.
- High heat resistance up to 425°F / 220°C (not to be used as a trivet).

Trivets

- Pot holder + trivet, the interlocking design turns the trivets into a table runner.
- High heat resistance up to 675°F / 355°C.

Handling & Care:

The correct handling and care of your Melamine buffet and tableware will enhance the appearance and longevity of the product in use. The following guide will assist you.

- Handle melamine dinnerware like any quality dinnerware.
- Clean as soon as possible to help avoid staining and protein build-up.
- Use only plastic pads or plastic type bristle to remove dried food.
- Pre-soak melamine products, if necessary, in a high quality pre-soak dishwashing detergent.
- Immediately remove any damaged or chipped melamine products from operational use.
- Melamine products can withstand heat up to 212°F (100°C).
- Do not use in oven, microwaves or expose to direct flame, this can cause cracking and blistering from the heat.
- Do not use with heat lamps, conveyor belts, or plate warmers.
- The use of serrated knives is not recommended on melamine products.
- To avoid chipping and scratching, do not strike melamine products with or on any hard surface while attempting to remove excess food.
- Do not use harsh or abrasive cleaners, steel wool, or metal scouring pads.
- Do not use chlorine bleach or chlorine-based sanitising solutions when caring for melamine products.
- Only use sanitisers developed for commercial use.
- To avoid chipping and scratching, do not overload your dishwasher rack.

Melamine is a thermosetting plastic that is strong, lightweight and hard with the look and feel of ceramic product. It is highly break and scratch resistant, but it is NOT 100% unbreakable, it can be scratched and broken.

Melamine is often used for dinnerware, mixing bowls and laminated counter tops because it resists acids, alkalis and most food stains.

Melamine is hard and smooth and can withstand some fairly warm temperatures, but it does absorb heat and will soften if it gets too hot. While melamine is perfectly safe when it comes in contact with warm temperatures, melamine is not microwavable.

In general, melamine products are not designed to withstand temperatures that exceed 100°C and should not be submerged in boiling water or placed in the oven.

Also, be sure to avoid exposure to hot objects or prolonged exposure to boiling water. Melamine is suitable for use over a bain-marie as the water is circa 70°C, to hold food above a temperature of 60°C.

Melamine is dishwasher safe (as long as the water temperature does not exceed the 100°C guidelines). Scouring powder should not be used, as it will scratch the surface, also never use chlorine bleach on melamine buffetware.

Destaining

- Periodically presoak melamine products before dishwashing to prevent staining and to maintain lustre.
- For staining, use an oxygen-releasing compound such as Dip-It XP (ECOLAB).
- Sponges or woven plastic pads are recommended for cleaning.
- Do not use harsh or abrasive cleaners, steel wool, or metal pot scouring pads to remove food or stains.

Gastronorm Size Guide

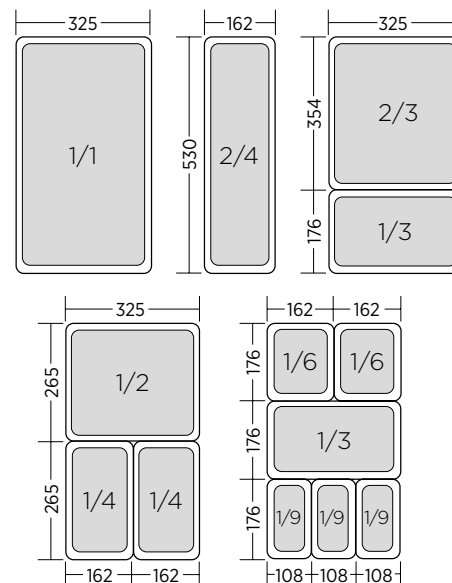

Food pans available in standard Gastronorm sizes.

Storing:

- Placing rubber or plastic mats on large stainless steel surfaces usually found in industrial kitchens can help reduce metal marking to ceramics.
- Rubber or plastic mats can also be placed in stacking areas, trolleys or sinks to further reduce the chance of metal marking.
- Replace or repair any plastic coated racks that may have become worn and the metal underneath exposed, as this again could cause damage to your ceramics.
- Do not stack items more than 15" high.
- Only stack products that are designated as stackable.

Using:

- Don't scrape off leftovers – wipe off with a paper towel or a plastic/rubber scraper.
- Do not slide items across each other to reduce abrasions.
- Minimise handling to reduce glaze abrasion.
- Be sure to rotate your stock to prevent uneven wear.
- Use cutlery that is of a high grade steel as a minimum requirement, as some cutlery in use today is made from low grade steel, which being soft in nature increases the chance of metal marking.
- Using metal utensils against ceramics can also cause metal marking, try to keep this to a minimum or use plastic utensils.

Washing:

- Seventy percent of product damage/loss occurs at the dishwasher table. To avoid such damage, ensure that the dishwasher table has sufficient space to store dirty items and avoid overloading trays or trolleys.
- To ensure the quality level of the product it is important to take note of the following:
- Items should be washed within 45 minutes of removal from the table and pre-rinsed.
- Abrasive cleaning aids should not be used, i.e. scouring pads, steel wool, etc.
- All items should be separated into type prior to washing.
- Stack ceramics separately to other crockery in the dishwasher such as cutlery or pans and ensure items do not vibrate against each other during the cycle.
- Avoid contact between ceramics, dinnerware and metals.
- Strictly follow recommended dishwashing procedures set out by the manufacturer and use the correct dose application of the detergent.
- The use of an approved detergent is recommended.

- For effective cleaning, we recommend that the dishwashing temperature and the final rinse be set between 55 to 60°C. Operating at higher temperature levels in order to wash crockery 'properly' is a definite case of overkill and detrimental to all tableware.
- Repair or replace any plastic coated metal in the dishwasher that may have worn away as this may result in metal marking.
- Overdosing on detergent or using excessively high temperatures will cause deterioration to the glazed finish or damage any decoration on the product.

Metal Marking:

- Metal marking occurs when a ceramic item comes into contact with metal surfaces or utensils, which can cause metal tracing to be left on the ceramic item due to certain types of steel being softer than the glaze of the ceramic.
- Despite the unsightly appearance of metal marking, it is not a cause for concern as it can be easily removed by the application of a gentle household non-abrasive cleaner.

Custom Decoration:

- Gold and platinum decorations are not microwave safe.
- Utopia ceramics are suitable for microwave use, however be advised that any decorated item that includes metal will not be microwave safe.
- Hand washing is recommended to prolong the metallic lustre of decoration.



Stainless Steel, though its name suggests otherwise, it is not completely 'mark proof'. It is much more resistant to staining or marking than other metals however contact with certain substances will start the process that leads to staining and pitting.

Storing:

- Never store cutlery where it can become damp, as this can cause corrosion.
- Store out of direct heat, as this can cause the metal to mark.
- Never leave cutlery with food on as many corrosive substances are found in food, such as acids, like vinegar and lemon juice, mineral salts found in tap water, fats and meat juices.
- Other corrosive substances are bleach and harsh detergents, so ensure your cutlery is not left to soak.
- Be sure cutlery is completely dry before storing in a dry location away from the kitchen.

Washing:

These products are specially designed to withstand the rigours of the Foodservice and Hospitality trade, including automatic dishwashing found widely in most businesses.

To ensure the quality level of the product it is important to take note of the following:

- When pre-rinsing cutlery ensure all food debris is removed before being washed.
- Follow the manufacturer's instructions, particularly in relation to adding dishwasher salt as excess salt can cause corrosion.
- Always wash cutlery immediately, never leaving it with food debris present.
- It is advisable to place cutlery vertically into dishwashers with the head up; and not too tightly packed together, this assists the water flow at the end of the cycle.
- Remove cutlery immediately after washing/dry cycle is finished and wipe over with a dry towel. If the cutlery is left to cool in the dishwasher, trace mineral salts and the dishwasher salt residue will settle on the cutlery in the moist atmosphere and start the pitting and staining process.
- Never mix stainless steel and silver plated cutlery in the same basket of the dishwasher the chemical reaction between detergent and steel can cause the silver plate to mark.
- Do not use the rinse and hold cycle on dishwashers with cutlery this will leave the cutlery to soak in water which can be damaging.



- Wood handled cutlery is not suitable for cleaning in a dishwasher.
- For PVD coated cutlery such as Gold extra care should be taken when washing.

Steak Knives:

Wood Handled Knives

- Handwashing is recommended for the best performance and optimal product life.
- Wash knives with warm water and a mild detergent, rinse well and dry thoroughly.
- Water and harsh detergents will dull the finish and dry out the handles.
- It is recommended that the wooden handles be oiled as needed.

ABS (Resin) Handled Knives

- Low temp dishwasher safe.
- Wash knives with warm water and a mild detergent, rinse well and dry thoroughly.
- Not recommended for high temp dishwashers that exceed 167°F / 75°C.
- Knives should not be exposed to extreme temperature changes, which will cause the abs handle material to crack over time.

Stainless Steel Knives

- Dishwasher safe.
- Wash knives with warm water and a mild detergent, rinse well and dry thoroughly.

Blade Sharpening

- Serrated blades cannot be sharpened.
- Blades with no serrations can be sharpened as needed.
- The frequency will depend on how often the knives are used and how well they are maintained.

Types of Metal – What is Stainless Steel?

Choosing the right type of cutlery for what you need it for can be confusing, Utopia have tried to simplify this by splitting the ranges into different types of stainless steel 18/10 and 18/0. These ranges can be further identified through the colour coded collections.

Stainless Steel is an iron and chromium alloy containing more than 11% chromium. There are three types of stainless steel used to make cutlery:



18/10

This is used for contemporary cutlery except knives; it contains 16-18% Chromium and 8-10% Nickel. This is the only steel that can guarantee against corrosion when properly cared for.

AISI Code	Generic	Chrome	Nickel	Others	Subtotal	Balance
304	18 / 10 or 18 / 8	16-18%	8-10%	3%	29-33%	Iron

18/0

This steel is used for value cutlery e.g. Parish, Economy or some value options of Contemporary cutlery. Due to the high % of chromium, it is more resistant than 13/10 but not as resistant as 18/10.

AISI Code	Generic	Chrome	Nickel	Others	Subtotal	Balance
430	18 / 0	16-18%	-	2	18-20%	Iron

13/0 or Knife Steel

This steel is used to make knives, as it can be hardened to create a sharp edge. The quality used is AISI 420, containing 12-14% chromium. This is the least corrosion resistant form of stainless steel.

AISI Code	Generic	Chrome	Nickel	Others	Subtotal	Balance
420	Knife Steel	12-14%	-	2	14-16%	Iron

Storing:

- Never use glass to carry or store cutlery.
- Do not stack glasses that have not been designed to stack.
- Use properly sized compartmented glass racks.

Polishing Stemware:

- Use white cotton gloves or 2 cloths for polishing.
- Polish the bowl first followed by the stem and then the base.
- Do not hold the glass by the stem or the base when polishing the bowl.

Using:

- Do not pick up glasses in clusters.
- Never let the beer tap come in contact with the glass.
- Do not use glassware as an ice scooper.
- Do not put cold liquids into hot or warm glasses straight from the dishwasher as this can cause cracks.
- Pre-heat glasses for hot drinks by running them under the hot tap.

Washing:

These products are specially designed to withstand the rigours of the Foodservice and Hospitality trade, including automatic glass washers found widely in most businesses.

To ensure the quality level of the product it is important to take note of the following:

- Always wash new glasses before use.
- Always use a non-caustic detergent as caustic detergents affect head retention, etch the glass and give the glass a shadowy tinge.
- Water on the premises should be stored at 60°C. If water is stored at a higher temperature e.g. 85°C, even when this is reduced because of travelling to the machine, it could still be high enough to bake debris onto the glass.
- Coffee cups should never be washed in a glass washing machine, as coffee dregs can taint the water and stain the glasses – this also applies to drinks that contain cream.
- If cracks or chips are found in glasses, they should be discarded immediately and never put in the dishwasher.
- Gold decorated glassware is suitable for handwash only.
- After washing, remove basket and leave to cool and dry.
- Do not handle stemware when hot.

**Information:**

See below for a guide to replacement seals for our Preserve Style Jars and Terrine collections.

Item Code	Item Description	Replacement Seal Code
N210965-00000-B01006	Preserving Jar 3.0L	N580139-00000-B01010
N210964-00000-B01006	Preserving Jar 2.0L	N580140-00000-B01010
N210963-00000-B01006	Preserving Jar 1.5L	N580140-00000-B01010
N210962-00000-B01012	Preserving Jar 1.0L	N580140-00000-B01010
N210961-00000-B01012	Preserving Jar 0.75L	N580140-00000-B01010
N210960-00000-B01012	Preserving Jar 0.5L	N580140-00000-B01010
N210982-00000-B01006	Terrine 350ml	N580140-00000-B01010
N210981-00000-B01012	Terrine 200ml	N580108-00000-B01010
N210980-00000-B01012	Terrine 125ml	N580108-00000-B01010
N210984-00000-B12072	Mini Terrine Jar 3.75"(8.5cm) 70ml	N580141-00000-B01010
N210983-00000-B12096	Mini Terrine Jar 2.75"(6cm) 50ml	N580141-00000-B01010
R90114-000000-B01012	Square Terrine 100ml 3.5oz (9.8cl)	N580141-00000-B01010
R90115-000000-B01012	Square Terrine 310ml 11oz (31cl)	N580108-00000-B01010

Improved working practices for the use of Polycarbonates will extend the life of the product:

- Polycarbonate drinkware is supplied with the verified CE Mark or Lined and Stamped exactly like Glassware.
- Polycarbonate Barware is dishwasher safe to a temperature of 60°C.
- When using glass washers, it has been suggested that the use of detergent without rinse aid is preferred.
- To maintain the product in its best condition, it is recommended that a low temperature wash cycle below 60°C for both wash and rinse temperature is used. The combination of detergents and raised temperatures can lead to environmental stress cracking in the plastic surface. If washer temperatures are above this then it is recommended to hand wash the plastic barware.
- It is important to make sure that the Polycarbonates are not rubbing together during the rinse cycle in a glass washer.
- It is safe to use Liquid Renovate. This will enhance the visual presentation of the product where needed.
- Regular checking of Polycarbonates to assess scratching is needed so as to offer the customer a perfect drink.
- It is important that Polycarbonates are not stacked tightly together as the inside of the product will scratch.
- Polycarbonates are quite often found on the floor and on hard floors they will scratch. Where possible Polycarbonates should not be left on the floor.
- Polycarbonate is a tough transparent thermoplastic that has many applications, which demand high performance properties.
- Dishwasher & freezer safe.
- Items must be carefully placed in the dishwasher while avoiding direct contact with other dishes and drinkware.
- Do not wash with harsh abrasives such as brushes or scrubber pads as this may cause scratches; harsh chemicals including strong acid or alkali cleaning agents should also be avoided.
- Use warm, soapy water or a neutral dishwashing liquid for cleaning.
- Dry naturally or with a soft cloth after hand washing; we recommended using a microfibre cloth to preserve clarity.
- Product can be used normally between temperatures of -30°C and 110°C (-22°F and 230°F).
- Avoid prolonged exposure to UV light, sunscreen or chlorine.
- Not recommended for use in microwaves or high temperature sterilisers.

Polycarbonate drinkware is almost indestructible, hard and rigid and in many cases virtually identical to glass. It is the preferred product for Police Forces and Local Licensing Authorities where drink related violence is an area of concern.

Although the product is virtually unbreakable it is subject to considerable wear and tear, unlike glass, which would simply break and then be replaced, regular checking of polycarbonates to assess scratching is needed as to offer the customer a perfect drink.

Utopia Drinkware:

Drinkware is supplied in four different types of plastic:

- Polystyrene – our plastics shots are Polystyrene, these are dishwasher safe up to 100 washes.
- SAN (Styreneacrylonitrile) is stronger than Polystyrene and can take a high amount of usage but will break under heavy pressure. This product is glass washer proof.
- Polycarbonate – is a very strong and virtually unbreakable plastic, the strongest plastic of all. Our polycarbonate glassware is glass washer safe up to 500 washes.
- MMS – is a transparent copolymerization primarily composed of methyl methacrylate (MMA) and styrene monomer (SM). This is glass washer safe up to 100 washes.

Polypropylene Lids, Stoppers & Bottoms:

- Do not use strong acid or strong alkaline cleaning agents.
- Temperature should not exceed more than 104°F (40°C).
- Avoid excessive water pressure as well as objects pressing on the product or it may cause deformation.

Index

18/10..... 76-77, 99, 108, 181-185

A

Acacia.....56, 58, 78-79, 156-157
Acacia Punch Barrel Stand..... 101
Accessories 52-53, 77, 91, 149, 152, 211
Additions.....185
Add-Ons..... 193, 195
Alumina Vitriified.....82-83
Aluminium..... 110
Ambient Buffet..... 50, 53
Amphora..... 165
Antique Brushed Bronze..... 65, 73
Anton Black120
Aqua 168
Artemis.....140
Ash59
Ash Grey.....29-31, 42, 49-52, 103, 105
Ash Grey Teak.....29, 42, 49-52, 103
Asos.....146-147
Aspen Everclear Drinkware.....176
Atlantic.....177
Atlantis 169
Aurora Revolution..... 33
Aurora Vesuvius.....65
Authentico.....165, 173
Avebury Blue.....86
Axis Beverage Collection ..26-27, 100
Axis Buffet Collection...11, 20-25, 104

B

Bakery Box41-42, 44, 46
Bakery Split Cover..... 35-36, 50, 53
Bamboo 59, 205
Barca 165
Beverage.....98-109
Beverage Service.....98-109
Birch.....158
Biscotti175
Bistro Jugs.....167
Bistrot 168
Bitters 154
Black.....11, 17, 27, 29-34, 36, 38, 40-41, 48-49, 52-53, 61, 67, 71, 73, 75-76, 85, 97, 100, 104, 111, 117, 120, 135, 139, 141, 144, 147, 152, 157, 159, 176, 179, 185, 193, 195, 199, 203, 205, 207, 208-209, 215, 219
Black Teflon.....29, 48
Black Teflon Risers.....48
Black Vintage Steel135, 141
Blonde 11
Blue.....32, 64-65, 82, 86, 132-134, 176, 179, 193, 208, 215
Bon Bon Punch Barrel 101
Bormioli Rocco.....35-36, 162-163, 168, 170-171, 173

Bottles 168-172
Bowls.....119
Breath Guards.....206-207
Brushed Stainless.....30, 73, 195, 207
Bryce 38-40, 185
Buffet Chillers 109
Burners.....89
Butter Cream..... 201

C

Caddies 155-157
Cake Stands & Domes 145
Calypso132
Cantine.....204-205
Canvas196-199
Carafes36, 39, 160-165, 176-177
Card Holder.....30, 34, 36, 38, 40, 53
Carlton.....185
Cast Iron 74-75, 78
Cast Iron & Boards..... 78-79
Cereal Dispensers27, 99, 104-107
Chafers 63, 66-77
Chafing Fuel..... 64, 89, 92-93
Champagne..... 11, 14-15, 20-21
Champagne Bowl..... 110
Champagne Bucket 111
Champagne Bucket Stand.....111
Chicago182
Chillers..... 108-109
Chrome..... 143-144, 154
Cobalt 164
Coffee Pot..... 150-151
Cold Buffet..... 50-51, 53
Compostable Paper Cutlery 159
Condiment Bottles173
Condiment Holder155
Condiments.....173
Conic167
Contemporary.....164, 166
Cookware82-83
Coolers 110-113
Copper.....41, 58, 61, 76, 110-112, 117, 141, 143-144, 154-155, 199
Cork Lid 163
Country Style Punch Barrel..... 101
Covers.....125, 209
Cover Up..... 42, 44, 46, 52
Craft..... 34-35, 41, 50, 82-83, 125-126
Craft Cookware 82
Crate199, 205
Cream..... 203
Creations 10-27, 30, 34, 39, 56, 65, 68-69, 72-73, 96-97, 100, 104-105, 122-131, 137, 185
Crown Glassware..... 164
Crystal Glassware..... 160-161, 166

D

Dante..... 154, 167
Dark Brown 11-19, 22-24

Dark-Lux..... 199
Darwin 58
Dash Bottles 154
Da Vinci.....111, 176
Design + Contemporary176
Diamond.....177
Discovery..... 58
Display Cart.....204-205
Dome..... 137, 152
Domes..... 145
Driftwood.....50, 125
D.W. Haber 28-53, 66-67, 70-71, 74-75, 90-91, 102-103, 105, 109, 116-117, 182-183

E

Eagle Enamel.....80-81
Easy Heat..... 64, 69, 92-93
Economy Wooden Cutlery158
Elise.....173
Elysia 165
Emilia..... 35
Era..... 169
Estrella..... 85
Eternal167
Excellent .. 76-77, 107, 109, 138, 151-153
Exclusiva.....162

F

Fast Food Trays.....215
Flame 58, 84
Fleur..... 138, 153
Folio 30, 33, 38-40, 184-185
Food Pans..... 67, 69, 71, 73, 213
Foodservice Equipment.....210-215
Forest Green..... 201
Fulton Vintage Copper..... 41
Fusion Buffet..... 24, 28-53

G

Gastronorm.....24, 30, 34-36, 39-40, 42, 44, 46, 50-51, 53, 123-125
Gatsby177
Giara171
Glass 145-147
Glass Tiles49
Gold 76, 140, 143-144, 154
Gourmande 58, 84
Granite.....133, 218
Graphite.....179
Green..... 82, 133, 197, 199, 209
Grey.....133
Grey Wash29, 44, 49-52, 103, 105
Grey Wash Teak29, 44, 49-52, 103
Gunmetal..... 112

H

Halo.....161
Hammered..... 34, 117, 183
Heater Stands 53

Heat Lamps.....	95, 96, 97	Modern.....	97	Pure.....	161
Hemingway.....	166	Modern-Twist.....	178-179	Q	
Hepp.....	76, 77, 106, 107, 108, 109, 138, 150, 151, 152, 153, 185	Modular.....	192-193, 209	Quarry.....	125, 128
Hill.....	147	Mogogo.....	186-209	Quick Cover Reference Guide.....	209
Hinged.....	66	Moresca.....	171-172		
Hinged Chafers.....	66, 67			R	
Hive.....	179	N		RCR Cristalleria.....	161
Holders.....	50, 155	Nantucket.....	101	Recycled Glassware.....	173
Hollow.....	147	Napkin Holder.....	155	Red.....	71, 75, 132
Hollowick.....	64, 69, 89, 92-93	Natural.....	199	Resin.....	29, 36, 49, 134
Hollowware.....	149-151	Natural Sugarcane Cutlery.....	159	Resin Tiles.....	49
Homestyle.....	65, 72, 74	Natural Teak.....	29, 32-33, 37-39, 46-47, 49-52, 103, 105	Reversible Platters.....	133
Homestyle Chafers.....	70-75	Neutral.....	77, 109, 138, 150-153	Revolution.....	32-33, 39
Hot Buffet.....	52	Niagra.....	167	Ria Swing Bottle.....	172
Hydraulic Chafers.....	68-69	Non-Slip Trays.....	215	Ribbed.....	101
		Nostalgia.....	154	Riser.....	24, 30-38, 40-48, 50-51, 53, 75, 119, 137-138
I		Nude.....	160-161, 166, 173	Roll'n.....	194-195, 209
Ice Bath.....	112-113	O		Romantic.....	168
Ice Bin.....	13, 35-36, 50, 53	Officina.....	162, 170	Rona.....	161, 166
Ice Bucket.....	111	Oil & Vinegar.....	173		
Ice Cell.....	24, 36, 50-51	Olive.....	57, 219	S	
Ice Lipped Waisted.....	167	Olive Wood.....	57	Salt Pot.....	173
Iconic.....	169	Onyx.....	11, 22-23	Satin.....	30, 38, 40, 53, 75, 113
Induction.....	38, 52, 63, 66-70, 72, 74, 76-77, 89-91	Oval.....	202-203	Sauce Bottle.....	154
Ink Nomad.....	32, 64-65	Oxford.....	171	Scape.....	130
Inserts.....	52-53, 77			Scoop.....	134
Inserts & Accessories.....	52-53	P		Seafood Stands.....	139
Italian Heritage.....	162, 170, 173	Paradise.....	177	Service Cart Add-Ons.....	195
Ivory.....	11	Pasabahce.....	165, 167	Service Carts.....	194-195
		Paulowinia Wood.....	157	Serving Spoons.....	185
J		Pebble Platters.....	133	Serving Utensils.....	180-185
Jugs.....	167-168, 177	Pepper.....	120	Shell.....	134
Juice Dispenser.....	107	Pepper Pot.....	173	Shelves.....	49, 193, 205
Juice Dispensers.....	27	Pink.....	147	Shelving System.....	196-199
Juicer.....	31, 43, 45, 47, 103	Pint Milk Bottle.....	169	Silicone.....	178-179
		Piri.....	173	Skewers.....	159
K		Pitcher.....	165, 168	Slate.....	39, 50, 60, 123, 125, 133, 142, 193, 195, 208
Kenny Mack Designs.....	134	Pitchers.....	165	Slate Presentation.....	60
		Pivot.....	11, 13-22, 24	Spire.....	11, 12-13, 16, 18-19, 21, 23
L		Placemats.....	178-179	Spoon Rest.....	38-40, 53, 182
Lidded Bottle.....	169	Plate Risers.....	144	Square Swing Bottle.....	172
Liquid Chafing Fuel.....	92-93	Plate Stands.....	142-143	Squeezy Bottles.....	154
Liquorice.....	35	Platters & Bowls.....	118-119, 122-134	Stainless Steel.....	29, 36, 37, 47-48, 52-53, 61, 75, 77, 80-81, 97, 109-112, 135-136, 140-141, 144, 154-155, 173, 182-185, 193, 195, 201, 207-208, 213
Lucent.....	177	Polished Stainless Steel Risers.....	48	Stainless Steel Food Pans.....	213
		Polycarbonate.....	9	Stands.....	53, 101, 111, 138-139, 143-145, 153
M		Polycarbonate Food Pans.....	213	Steelite Performance.....	32-35, 39, 41, 64-65, 82-83
Marine Blue Pearl.....	134	Polycrystal.....	176	Stone.....	123, 125
Marmites.....	63	Pompeii.....	122, 125	Stoneware.....	84, 86
Maroon.....	201	Porcelain.....	24, 40, 51, 67, 69, 71, 73, 75, 77, 87, 120, 121	Storage Jars.....	175
Matt Black.....	112, 144	Pourer.....	154, 173	Strahl.....	111, 176
Melamine.....	39, 122-133, 137, 185	Powder Coating.....	114-117	Street Food Stands.....	61
Melodia.....	161	Power Cell.....	42, 44, 46, 52, 90-91		
Midnight.....	84	Presentation Stands.....	140-141		
Milk.....	27, 104-107, 150-151	Preserving Style Jars.....	174		
Milk Bottle.....	169	Profile.....	151, 153		
Millennium.....	102, 105	Punch Barrel.....	101		
Misura PZ.....	162	Punch Barrel Taps.....	101		
Moby.....	200-201				

Studio Jugs167
Summit.....176
Swing Bottle171-172
Symphony..... 164

T

Table Caddies.....156, 157
Tangerine..... 134
Tangerine Pearl..... 134
Taste 35
Teapot.....151
Tempo..... 102-103, 105, 117
Terracotta..... 82, 85, 87, 218
Terrines.....174
Tiles 49-50
Timeless Vintage 165, 167
Titan.....87, 121
Tong.....30, 32, 34, 39-40, 183, 185
Tongs..... 183
Tortoise..... 134
Tower.....102, 105
Trays124, 211, 215
Trivets..... 178-179

U

Universal Cover Holder.....53, 75
Urban34
Utopia55, 57-61, 63, 78-81,
84-89, 99, 101, 110-113, 119, 121, 132-133,
135-136, 140-147, 149, 154-159, 164, 167,
169, 171-175, 181, 211-215

V

Vanilla.....203
Varick 41
Vertis 169
Vesuvius..... 32, 65
Vidrios San Miguel.....165, 173
Village 165
Vinegar Bottle.....173
Vini.....161
Vintage Black.....141
Vintage Copper.....141
Vintage Gold.....140
Vintage Steel.....135-136, 140-141
Vision..... 109, 177
Visual Display 55
V-Shield.....206-207

W

Waste Containers.....211, 215
Wave..... 134
White.....24, 36, 40-41,
50-51, 67, 69, 71, 73, 75, 82, 87, 117, 127,
132-133, 147, 157, 193, 195, 208
Whiteware..... 120
Wildwood.....133
William Edwards 143
Williamsburg Metalworks..... 139
Wine Buckets 110-113
Wine Cooler109
Wine Stand.....109
Wood.....11, 22-23, 30-31, 34, 36, 43,
45, 47, 49, 53, 56, 75, 103, 152, 156-157,
193, 195, 208, 220
Wood Display.....56
Wood Effect Platters.....133, 176
Wooden Cutlery.....158
Wood Presentation 59
Wood Tiles.....49

Y

Ypsilon 36, 39, 163



steeliteutopia

THE ART OF PRESENTATION

Steelite-Utopia Head Office

1 Langham Park
Mansfield Road
Chesterfield
S41 0GG, England
Telephone +44 (0)1246 858 800
Email info@steelite-utopia.com

Chesterfield Showroom

The Showroom is available by appointment,
please call or email to make a booking.

London Showroom

Steelite-Utopia
Palladium House
1-4 Argyll Street
2nd Floor
London, W1F 7LD
Email info@steelite-utopia.com

The Showroom is available by appointment,
please call or email to make a booking.

Steelite International Factory

Steelite International Ltd
Orme Street
Stoke-on-Trent
ST6 3RB, England
Telephone +44 (0)1782 821 000
Email headoffice@steelite.com

Stoke-on-Trent Showroom

The Showroom is available by appointment,
please call or email to make a booking.

www.steelite-utopia.com

f SteeliteUtopia
@ SteeliteUtopia
in Steelite-Utopia







steeliteutopia
THE ART OF PRESENTATION



www.steelite-utopia.com

-  SteeliteUtopia
-  SteeliteUtopia
-  Steelite-Utopia

TCAT SERVE UKI 2026